

 **LEXUS**
GS 450h

Hybrid
2007 Model

Emergency Response Guide



© 2006 Toyota Motor Corporation
All rights reserved. This document may not be
altered without the written permission of Toyota Motor Corporation.

07GS450hERG REV – (4/21/06)

Foreword

In April 2006, Lexus released the Lexus GS450h gasoline-electric hybrid vehicle in North America. Except where noted in this guide, basic vehicle systems and features for the GS450h are the same as those on the conventional, non-hybrid, Lexus GS430/300. To educate and assist emergency responders in the safe handling of the GS450h hybrid technology, Lexus published this GS450h Emergency Response Guide.

High voltage electricity powers the electric motor, generator, A/C compressor, and inverter/converter. All other automotive electrical devices such as the horn, radio, and gauges are powered from a separate 12-Volt battery. Numerous safeguards have been designed into the GS450h to help ensure the high voltage, approximately 288-Volts, Nickel Metal Hydride (NiMH) Hybrid Vehicle (HV) battery pack is kept safe and secure in an accident.

The GS450h utilizes the following electrical systems:

- Maximum 650-Volts AC
- Nominal 288-Volts DC
- Maximum 37-Volts AC / DC
- Nominal 12-Volts DC

GS450h Features:

- First *Hybrid Synergy Drive* to utilize rear wheel drive exclusively.
- A boost converter in the inverter assembly that boosts to 650-Volts the available voltage to the electric motor.
- The high voltage hybrid vehicle battery pack is rated at 288-Volts.
- A high voltage motor driven air conditioning compressor rated at 288-Volts.
- High voltage High Intensity Discharge (HID) headlights.
- A high voltage Electric Power Steering (EPS) assist motor rated at 37-Volts.
- The body electrical system rated at 12-Volts negative chassis ground.
- An optional active stabilizer suspension system with a separate 12-Volt battery.

- Supplemental Restraint System (SRS) - dual stage frontal airbags, front knee airbags, front seat and optional rear seat side airbags, side curtain airbags, and front seat belt pretensioners.

High voltage electrical safety is an important factor in the emergency handling of the GS450h *Hybrid Synergy Drive* system. It is important to recognize and understand the disabling procedures and warnings throughout the guide.

Additional topics in the guide include:

- Lexus GS450h identification.
- Major *Hybrid Synergy Drive* component locations and descriptions.
- Extrication, fire, recovery, and additional emergency response information.
- Roadside assistance information.



This guide is intended to assist emergency responders in the safe handling of a Lexus GS450h hybrid vehicle during an incident.

NOTE:

Emergency Response Guides for Lexus alternative fuel vehicles may be viewed at <http://techinfo.lexus.com>.

| Table of Contents | Page |
|---|-------------|
| About the GS450h | 1 |
| GS450h Identification | 2 |
| Hybrid Synergy Drive Component Locations & Descriptions | 5 |
| Smart Access System & Push Button Start | 8 |
| Hybrid Synergy Drive Operation | 10 |
| Hybrid Vehicle (HV) Battery Pack | 11 |
| Low Voltage Batteries | 12 |
| High Voltage Safety | 13 |
| SRS Airbags & Seat Belt Pretensioners | 15 |
| Emergency Response | 17 |
| Extrication | 17 |
| Fire | 21 |
| Overhaul | 21 |
| Recovery/Recycling of the NiMH HV Battery Pack | 22 |
| Spills | 22 |
| First Aid | 23 |
| Submersion | 23 |
| Roadside Assistance | 24 |

About the GS450h

The GS450h sedan joins the RX400h as a hybrid model for Lexus. *Hybrid Synergy Drive* means that the vehicle contains a gasoline engine and an electric motor for power. The two hybrid power sources are stored on board the vehicle:

1. Gasoline stored in the fuel tank for the gasoline engine.
2. Electricity stored in a high voltage Hybrid Vehicle (HV) battery pack for the electric motor.

The result of combining these two power sources is improved fuel economy and reduced emissions. The gasoline engine also powers an electric generator to recharge the battery pack; unlike a pure all electric vehicle, the GS450h never needs to be recharged from an external electric power source.

Depending on the driving conditions one or both sources are used to power the vehicle. The following illustration demonstrates how the GS450h operates in various driving modes.

- ❶ During light acceleration at low speeds, the vehicle is powered by the electric motor. The gasoline engine is shut off.
- ❷ During normal driving, the vehicle is powered mainly by the gasoline engine. The gasoline engine also powers the generator to recharge the battery pack.

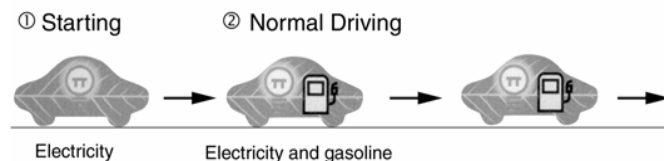

- ❸ During full acceleration, such as climbing a hill, both the gasoline engine and the electric motor power the vehicle.
- ❹ During deceleration, such as when braking, the vehicle regenerates the kinetic energy from the rear wheels to produce electricity that recharges the battery pack.
- ❺ While the vehicle is stopped, the gasoline engine and electric motor are off, however the vehicle remains on and operational.

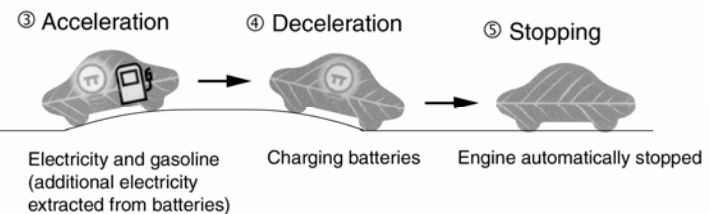

GS450h Identification

In appearance, the 2007 GS450h is nearly identical to the conventional, non-hybrid Lexus GS430/300. The GS450h is a 4-door sedan. Exterior, interior, and engine compartment illustrations are provided to assist in identification.

The alphanumeric 17 character Vehicle Identification Number (VIN) is provided in the front windshield cowl, driver door pillar, and engine compartment.

Example VIN: JTHBC96S840020208

A GS450h is identified by the first 6 alphanumeric characters **JTHBC9**.

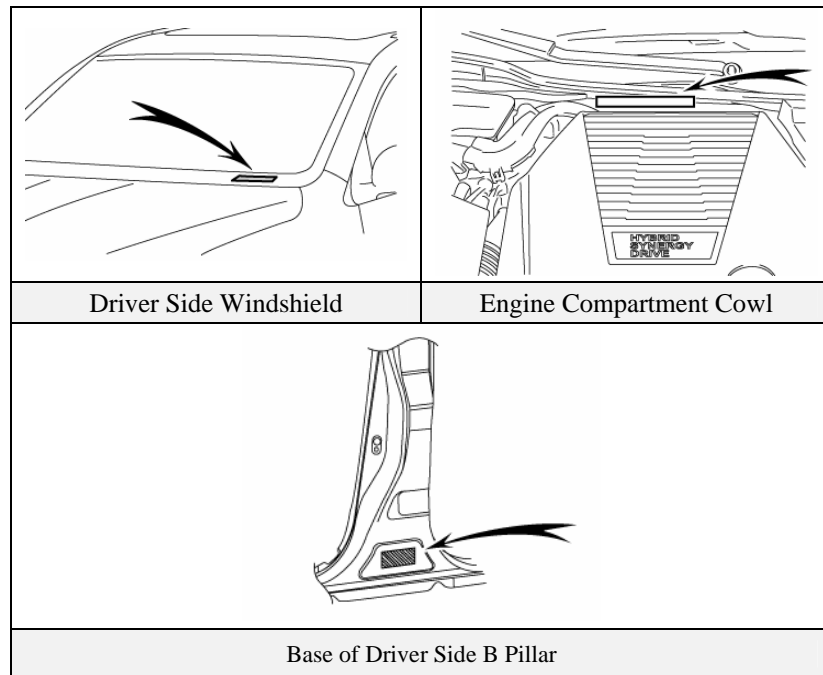

Exterior

- ① **LEXUS GS 450h** logos on the rear trunk.
- ② **HYBRID** logos on the rear door molding.
- ③ Gasoline fuel filler door located on the driver side rear quarter panel

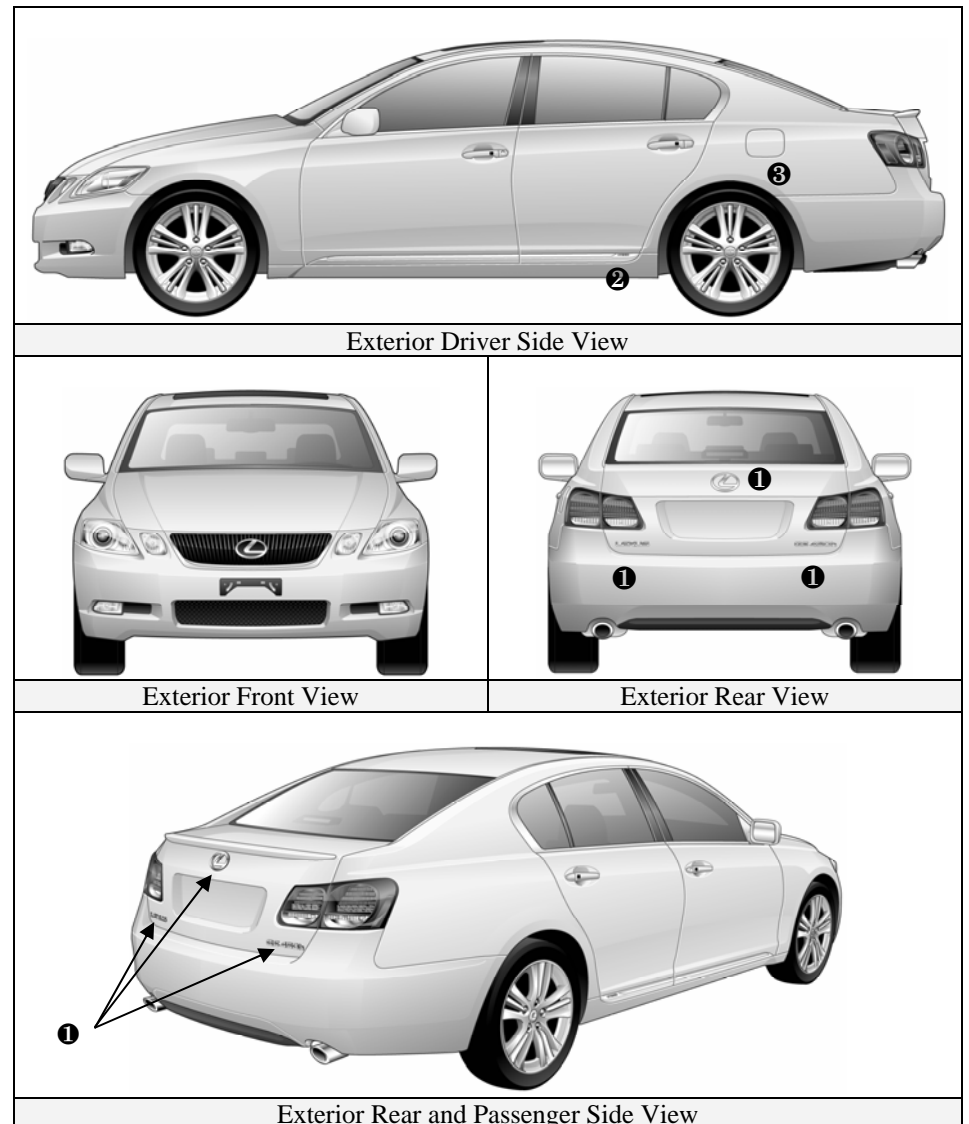

GS450h Identification (Continued)

Interior

- ④ The instrument cluster (speedometer, fuel gauge, warning lights) located in the dash behind the steering wheel, is different than the one on the conventional, non-hybrid GS430/300.
- ⑤ In place of a tachometer, a power meter showing kW output is used.

NOTE:

If the vehicle is shut off, the instrument cluster gauges will be “blacked out,” not illuminated.

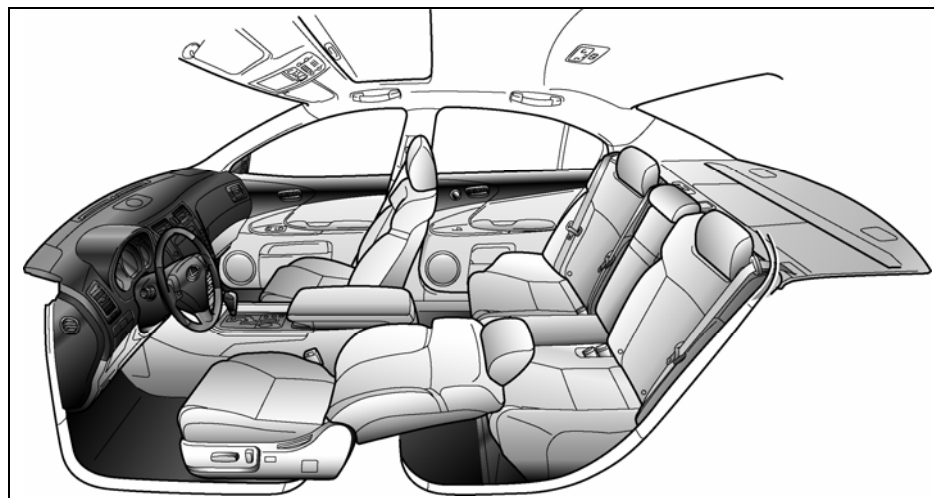

Interior View

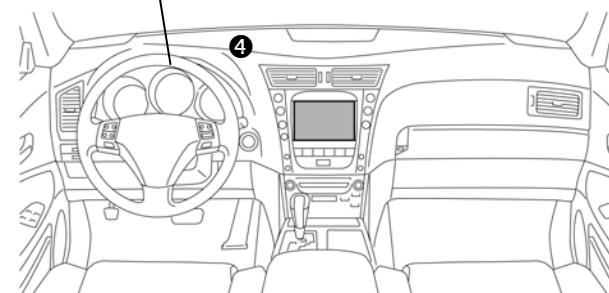
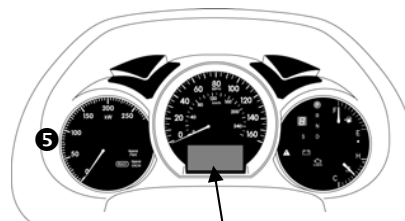

Instrument Cluster View

GS450h Identification (Continued)

Engine Compartment

- ⑥ 3.5- liter aluminum alloy gasoline engine.
- ⑦ Logos on the plastic engine cover.

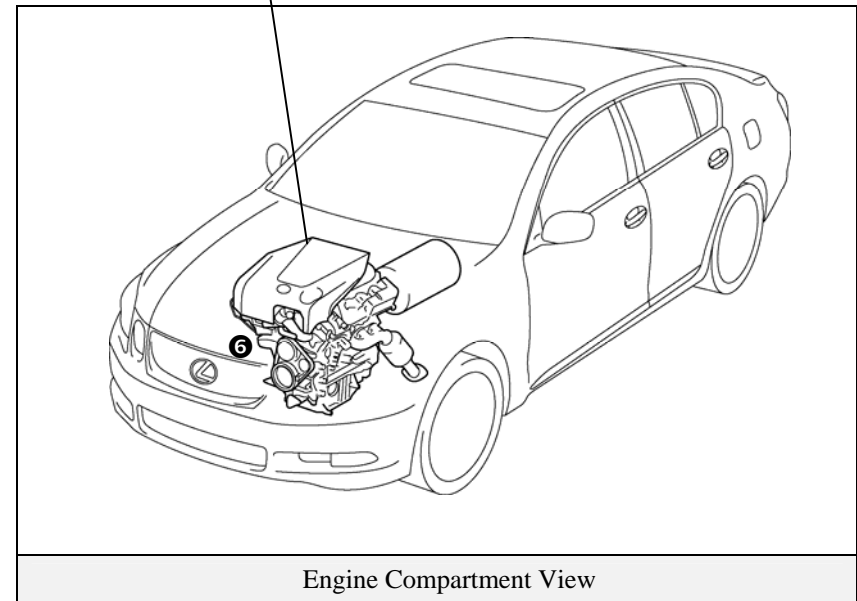
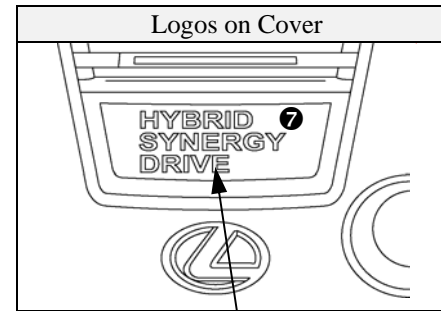

Hybrid Synergy Drive Component Locations & Descriptions

| Component | Location | Description |
|--|---|--|
| 12-Volt ❶ Auxiliary Battery | Trunk | A lead-acid battery that supplies power to the low voltage devices. |
| Hybrid ❷ Vehicle (HV) Battery Pack | Trunk Area, Mounted to Cross Member and behind Rear Seat | 288-Volt Nickel Metal Hydride (NiMH) battery pack consisting of 40 low voltage (7.2-Volt) modules connected in series. |
| Power ❸ Cables | Under Carriage and Engine Compartment | Orange colored power supply cables carry high voltage Direct Current (DC) between the HV battery pack, inverter/converter, and A/C compressor. These cables also carry 3-phase Alternating Current (AC) between the inverter/converter, electrical motor, and generator. |
| Inverter/ Converter❹ | Engine Compartment | Boosts and inverts the high voltage electricity from the HV battery pack to 3-phase AC electricity that drives the electric motor. The inverter/converter also converts AC electricity from the electric generator and electric motor (regenerative braking) to DC that recharges the HV battery pack. |
| Gasoline ❺ Engine | Engine Compartment | Provides two functions: 1) powers vehicle: 2) powers generator to recharge the HV battery pack. The engine is started and stopped under control of the vehicle computer. |
| Electric ❻ Generator | Transmission | 3-phase high voltage AC generator that is contained in the transmission and recharges the HV battery pack. |
| Electric ❼ Motor | Transmission | 3-phase high voltage AC permanent magnet electric motor contained in the transmission and drives the rear wheels through the propeller shaft. |
| A/C ❸ Compressor | Engine Compartment | 3-phase high voltage AC electrically driven motor compressor. |

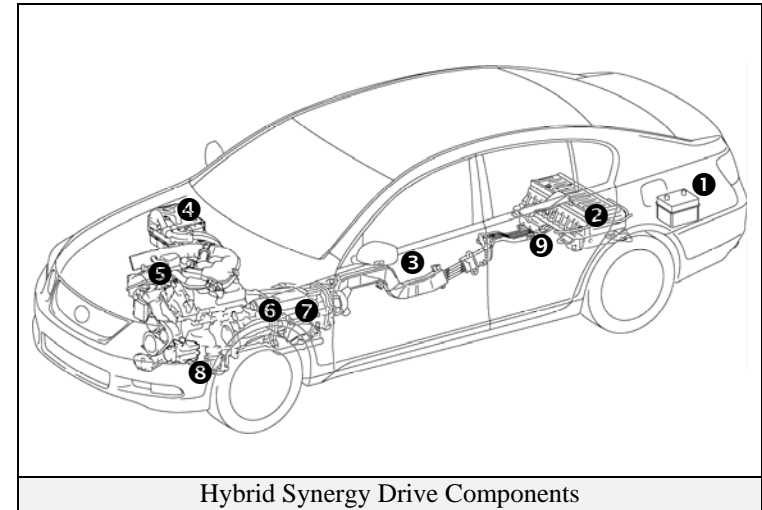

Hybrid Synergy Drive Components

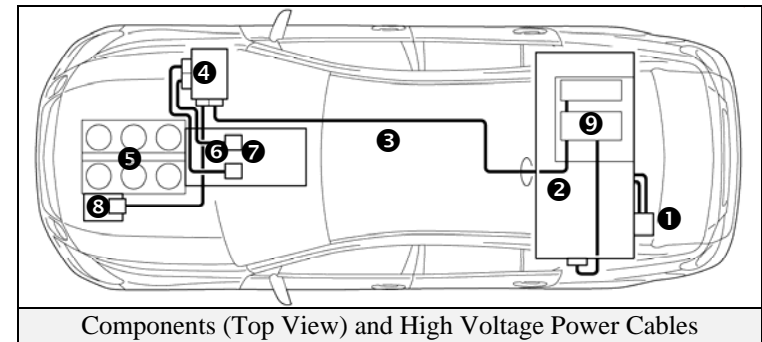

Components (Top View) and High Voltage Power Cables

Hybrid Synergy Drive Component Locations & Descriptions (Continued)

| Component | Location | Description |
|----------------------------|---------------------------------------|--|
| DC-DC Converter ⑨ | Trunk under HV Battery Pack | Converts 288-Volts from the HV battery pack to 12-Volts for low voltage vehicle power. |
| Fuel Tank ⑩ and Fuel Lines | Undercarriage, Driver Side and Center | The fuel tank provides gasoline via fuel lines to the engine. The fuel lines are routed along the driver side and center tunnel under the floor pan. |

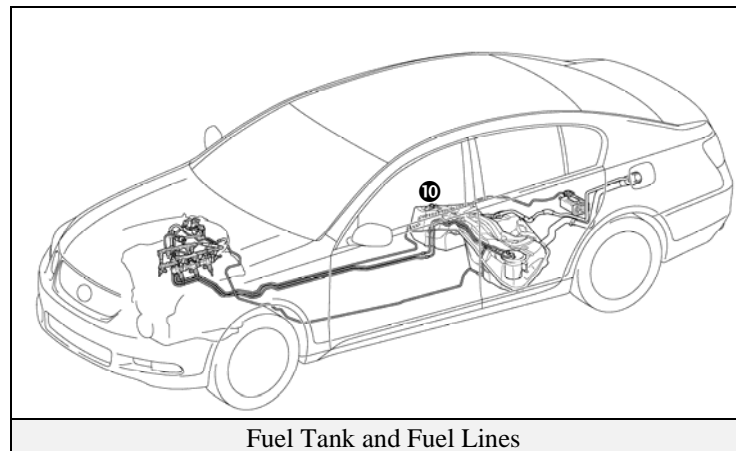

Fuel Tank and Fuel Lines

Smart Access System & Push Button Start

The GS450h smart access system consists of a smart key transceiver that communicates bi-directionally enabling the vehicle to recognize the smart key in close proximity to the vehicle. Once recognized, the smart key will allow the user to lock and unlock the doors without pushing smart key buttons, and start the vehicle without inserting it into an ignition switch.

Smart key features:

- Passive (remote) function to lock/unlock the doors and start the vehicle.
- Wireless transmitter to lock/unlock the doors.
- Hidden metal cut key to lock/unlock the doors from the exterior door lock.

Door (Lock/Unlock)

Three methods are available to lock/unlock the doors.

1. Pushing wireless smart key lock/unlock buttons.
2. Touching the sensor on the backside of any exterior door handle, with the smart key in close proximity to the vehicle, unlocks the doors. Pushing the lock button on any exterior door handle locks the doors.
3. Inserting the hidden metal cut key in the driver door lock and turning clockwise once unlocks the driver door, twice unlocks all doors. To lock all doors turn the key counter-clockwise once. Only the driver door contains an exterior door lock for the metal cut key.

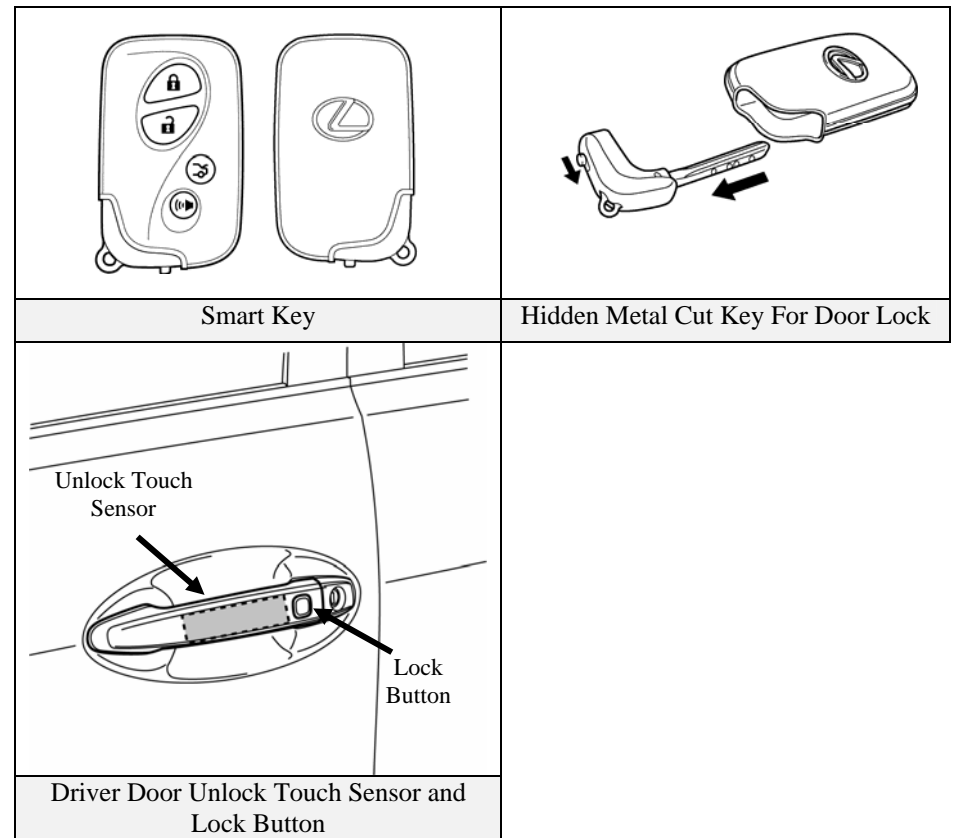

Smart Access System & Push Button Start (Continued)

Vehicle Starting/Stopping

The smart key has replaced the conventional metal cut key, and the power button with an integral status indicator light has replaced the ignition switch. The smart key only needs to be in proximity to the vehicle.

- With the brake pedal released, the first push of the power button operates the accessory mode, the second push operates the ignition-on mode, and the third push turns the ignition off again.

Ignition Mode Sequence (Brake pedal released):

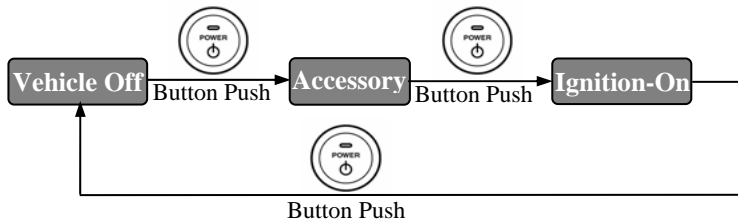

- Starting the vehicle takes priority over all other ignition modes and is accomplished by depressing the brake pedal and pushing the power button once. To verify the vehicle has started, the power button status indicator light is off and the **READY** light is illuminated in the instrument cluster.
- If the internal smart key battery is dead, it cannot communicate with the vehicle. In order for the vehicle to recognize the smart key, the driver must hold the smart key next to the power button while pushing.
- Once the vehicle has started and is on and operational (**READY-ON**), the vehicle is shut off by bringing the vehicle to a complete stop, placing the gearshift lever in **Park**, and then depressing the power button once.

| Ignition Mode | Power Button Indicator Light |
|----------------------------|------------------------------|
| Off | Off |
| Accessory | Amber |
| Ignition-On | Amber |
| Brake Pedal Depressed | Green |
| Vehicle Started (READY-ON) | Off |
| Malfunction | Blinking Amber |

| | |
|--|---|
| | |
| <p>Power Button with Integral Status Indicator Light</p> | <p>Ignition Modes (Brake Pedal Released)</p> |
| | |
| <p>Starting Sequence (Brake Pedal Depressed)</p> | <p>Smart Key Recognition (When Smart Key Battery is Dead)</p> |

Hybrid Synergy Drive Operation

Once the **READY** indicator is illuminated in the instrument cluster, the vehicle may be driven. However, the gasoline engine does not idle like a typical automobile and will start and stop automatically. It is important to recognize and understand the **READY** indicator provided in the instrument cluster. When lit, it informs the driver that the vehicle is on and operational even though the gasoline engine may be off and the engine compartment is silent.

Vehicle Operation

- With the GS450h, the gasoline engine may stop and start at any time while the **READY** indicator is on.
- Never assume that the vehicle is shut off just because the engine is off. Always look for the **READY** indicator status. The vehicle is shut off when the **READY** indicator is off.
- The vehicle may be powered by:
 1. The electric motor only.
 2. The gasoline engine only.
 3. A combination of both the electric motor and the gasoline engine.
- The vehicle computer determines the mode in which the vehicle operates to improve fuel economy and reduce emissions. The driver cannot manually select the mode.

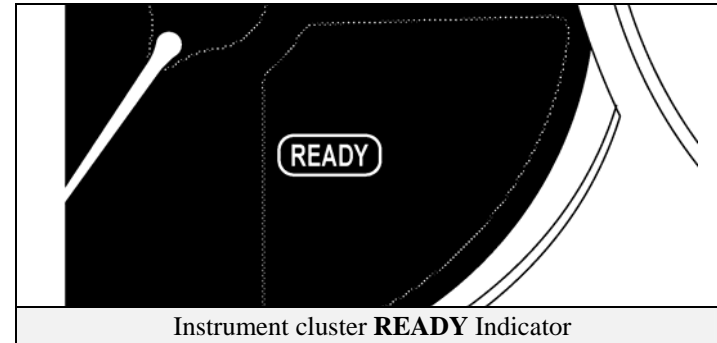

Hybrid Vehicle (HV) Battery Pack

The GS450h contains a high voltage, Hybrid Vehicle (HV) battery pack that contains sealed Nickel Metal Hydride (NiMH) battery modules.

HV Battery Pack

- The HV battery pack is enclosed in a metal case and is securely mounted in the trunk area behind the rear seat. The metal case is isolated from high voltage and concealed by fabric covers.
- The HV battery pack consists of 40 low voltage (7.2-Volt) NiMH battery modules connected in series to produce approximately 288-Volts. Each NiMH battery module is non-spillable and sealed in a plastic case.
- The electrolyte used in the NiMH battery module is an alkaline mixture of potassium and sodium hydroxide. The electrolyte is absorbed into the battery cell plates and forms a gel that will not normally leak, even in a collision.
- In the unlikely event that the battery pack is overcharged, the modules vent gases directly outside the vehicle through a vent hose.

| HV Battery Pack | |
|--|---|
| Battery pack voltage | 288 V |
| Number of NiMH battery modules in the pack | 40 |
| NiMH battery module voltage | 7.2 V |
| NiMH battery module dimensions | 5 x 1 x 11 in (118 x 20 x 276 mm) |
| NiMH module weight | 2.3 lbs (1.0kg) |
| NiMH battery Pack dimensions | 13 x 37 x 19 in (333 x 952 x 484 mm) |
| NiMH battery Pack weight | 152.1 lbs (69 kg) |

Components Powered by the HV Battery Pack

- Electric Motor
- Inverter/Converter
- A/C Compressor
- Power Cables
- DC-DC Converter
- Electric Generator

HV Battery Pack Recycling

- The HV battery pack is recyclable. Contact the nearest Lexus dealer, or:

United States: (800) 255-3987, Canada: (800) 265-3987

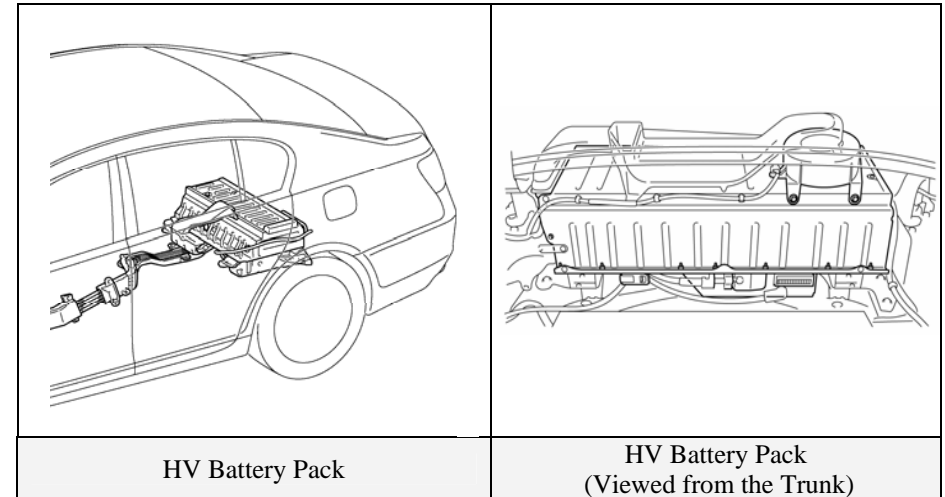

HV Battery Pack

HV Battery Pack
(Viewed from the Trunk)

Low Voltage Batteries

Auxiliary Battery

- The GS450h contains a lead-acid 12-Volt battery. The 12-Volt auxiliary battery powers the vehicle's electrical system similar to a conventional vehicle. As with conventional vehicles, the auxiliary battery is grounded to the metal chassis of the vehicle.
- The auxiliary battery is located in trunk. It is concealed by a fabric cover on the driver side in the rear quarter panel well.

Optional Active Stabilizer Suspension System Battery

- The GS450h may be optionally equipped with an active stabilizer suspension system powered by a separate 12-Volt lead-acid battery. Similar to the auxiliary battery, the 12-Volt active stabilizer suspension system battery is grounded to the metal chassis of the vehicle.
- When equipped with the optional active stabilizer suspension system, the GS450h is equipped with run-flat tires, and no spare tire. The active stabilizer suspension system battery is located in the trunk, and concealed under deck fabric and tool tray in the spare tire well.

NOTE:

The 12-Volt battery for the optional active stabilizer suspension system does not power the vehicle's low voltage system. Responders need to identify and distinguish the auxiliary battery from the active stabilizer suspension system battery. When in doubt, during power disconnect, disable both 12-Volt batteries in the trunk.

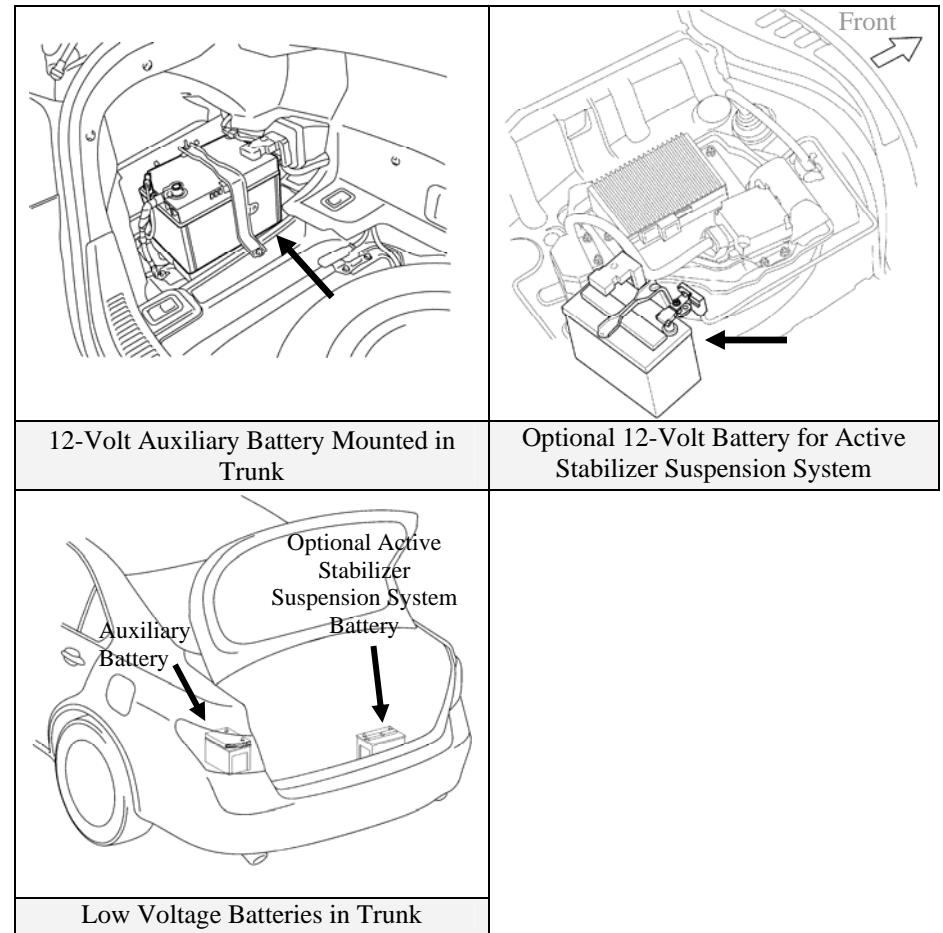

High Voltage Safety

The HV battery pack powers the high voltage electrical system with DC electricity. Positive and negative orange colored high voltage power cables are routed from the battery pack, under the vehicle floor pan, routed along the passenger side propeller shaft and transmission tunnel to the inverter/converter. The inverter/converter contains a circuit that boosts the HV battery voltage from 288 to 650-Volts DC. The inverter creates 3-phase AC to power the motor and generator located in the transmission. Power cables are routed from the inverter to each high voltage motor (electrical motor, electric generator, and A/C compressor). The following systems are intended to help keep occupants in the vehicle and emergency responders safe from high voltage electricity:

High Voltage Safety System

- A high voltage fuse ❶ provides short circuit protection in the HV battery pack.
- Positive and negative high voltage power cables ❷ connected to the HV battery pack are controlled by 12-Volt normally open relays ❸. When the vehicle is shut off, the relays stop electrical flow from leaving the HV battery pack.

⚠ WARNING:

The high voltage system may remain powered for up to 10 minutes after the vehicle is shut off or disabled. To prevent serious injury or death from severe burns or electric shock, avoid touching, cutting, or opening any orange high voltage power cable or high voltage component.

- Both positive and negative power cables ❷ are insulated from the metal chassis, so there is no possibility of electric shock when touching the metal chassis.
- A ground fault monitor ❹ continuously monitors for high voltage leakage to the metal chassis while the vehicle is running. If a malfunction is detected, the hybrid vehicle computer ❹ will illuminate the master warning light ⚠ in the instrument cluster and indicate “CHECK HYBRID SYSTEM” on the multi-information display.
- The HV battery pack relays will automatically open to stop electricity flow in a collision sufficient to activate the SRS.

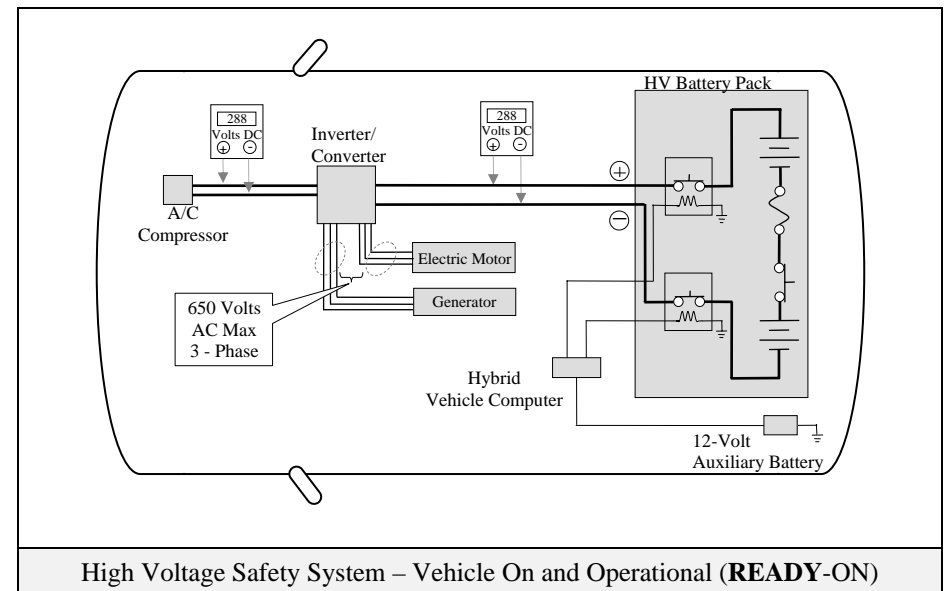
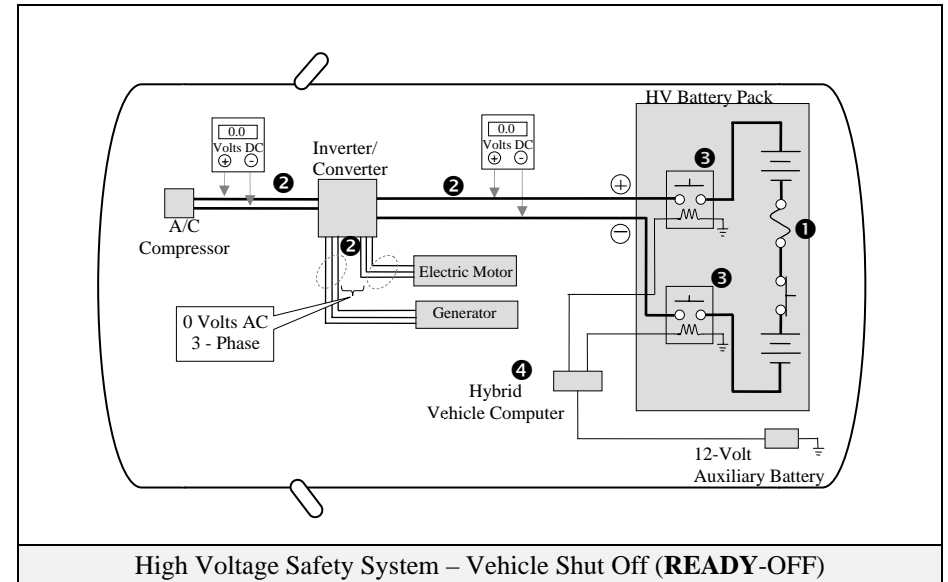

High Voltage Safety (Continued)

Electronic Power Steering System

The GS450h is equipped with a 37-Volt AC assist motor for the Electric Power Steering (EPS) system. The EPS computer generates 37-Volts from the 12-Volt system. The 37-Volt wires are isolated from the metal chassis and are routed a short distance from the EPS computer to the EPS assist motor in the engine compartment.

NOTE:

37-Volt AC has a higher arc potential than the normal 12-Volt DC.

High Intensity Discharge Headlights

Similar to conventional, non-hybrid, Lexus vehicles, the GS450h is equipped with low beam projector type High Intensity Discharge (HID) headlights. The light control unit, located inside the headlight assembly, contains a high voltage generator circuit that momentarily boosts 12-Volts to 22-kV that is applied to the bulb when the headlights are turned on. Once illuminated, the voltage drops to approximately 45-Volts.

⚠ WARNING:

High voltage is applied to the HID bulb socket when the low beam headlights are turned on. To avoid serious injury or death by electric shock do not touch the bulb socket when the headlights are turned on.

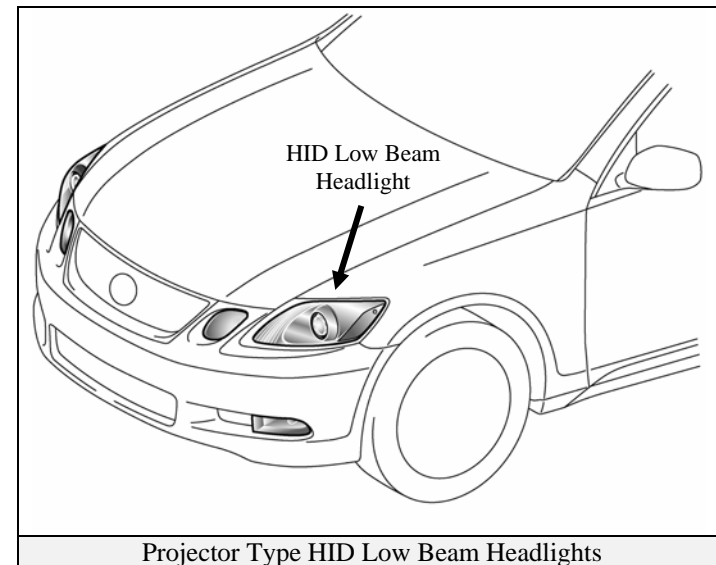
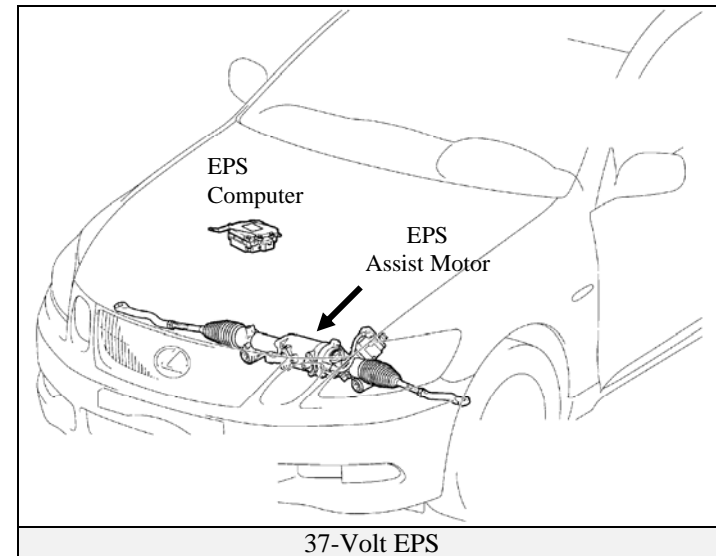

SRS Airbags & Seat Belt Pretensioners

Standard Equipment

- Electronic frontal impact sensors (2) are mounted in the engine compartment ❶ as illustrated on the following page.
- Front seat belt pretensioners are mounted near the base of the B-pillar ❷.
- A frontal dual stage airbag for the driver ❸ is mounted in the steering wheel hub.
- A frontal dual stage airbag for the front passenger ❹ is integrated into the dashboard and deploys through the top of the dashboard.
- The SRS computer ❺ is mounted on the floor pan underneath the center console. It also contains an impact sensor.
- Front electronic side impact sensors (2) are mounted near the base of the B-pillars ❻.
- Rear electronic side impact sensors (2) are mounted near the base of the C-pillars ❼.
- Front seat side impact airbags ❸ are mounted in the seatbacks.
- Side curtain airbags ❹ are mounted along the outer edge inside the roof rails.
- Front knee airbags ❷ are mounted on the driver side and passenger side lower portion of the dash.

Optional Equipment

- Rear seat side impact airbags ❶ mounted in the rear seats are optional equipment.
- A pre-crash safety system containing a radar sensory system, occupant seat sensor, and an electric motor-pyrotechnic pretensioner system. During a pre-collision event, an electric motor in the pretensioners retracts the slack in the front seatbelts. When conditions stabilize the electric motor will reverse itself. When the airbags deploy, the pyrotechnic pretensioners function normally.

NOTES:

The front seatback mounted side impact airbags and the side curtain airbags may deploy independently of each other.

The knee airbags deploy simultaneously with the frontal airbags and seat belt pretensioners.

The GS 450h is equipped with a standard front passenger occupant classification system that may prohibit the deployment of the front passenger frontal airbag, knee airbag, seatback mounted side impact airbag, and seat belt pretensioner. If the passenger occupant classification system prohibits deployment during an SRS event, the passenger SRS will not re-arm nor deploy.

⚠ WARNING:

The SRS may remain powered for up to 90 seconds after the vehicle is shut off or disabled. To prevent serious injury or death from unintentional SRS deployment, avoid breaching the SRS components.

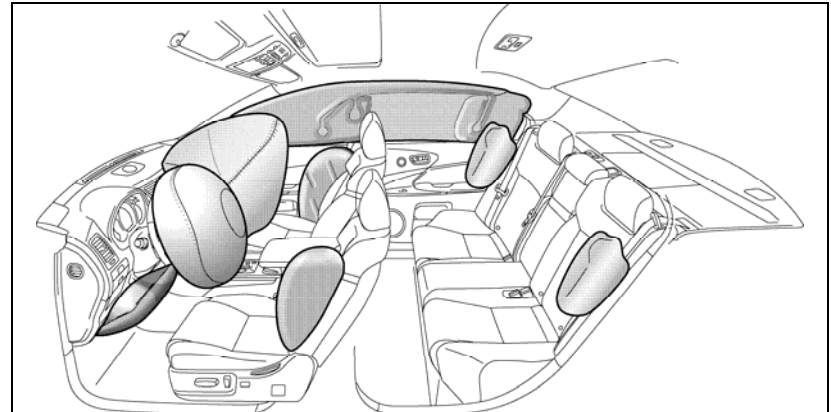

Frontal, Knee, Front Seatback Mounted Side, Side Curtain, and Optional Rear Seat Side Airbags

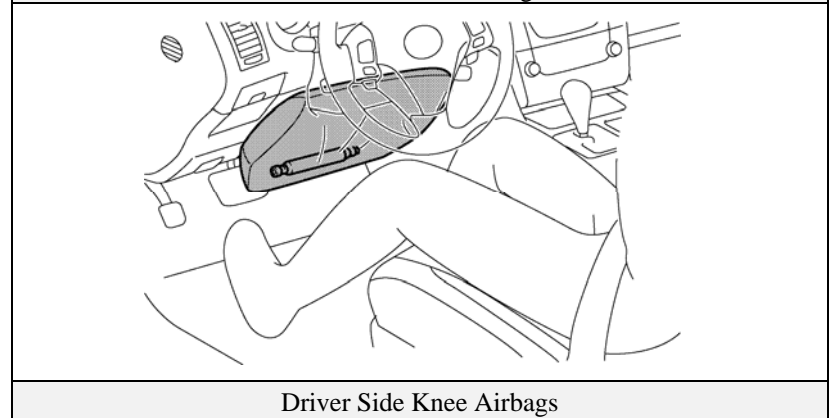

Driver Side Knee Airbags

SRS Airbags & Seat Belt Pretensioners (Continued)

| | | |
|---|---|--|
| | | |
| <p>Electronic Impact Sensors, Front and Optional Rear Seat Side Airbags</p> | <p>Standard Frontal Airbags, Seat Belt Pretensioners, Knee Airbags, and Side Curtain Airbags.</p> | <p>Side Curtain Airbag Inflator in Roof Rail</p> |

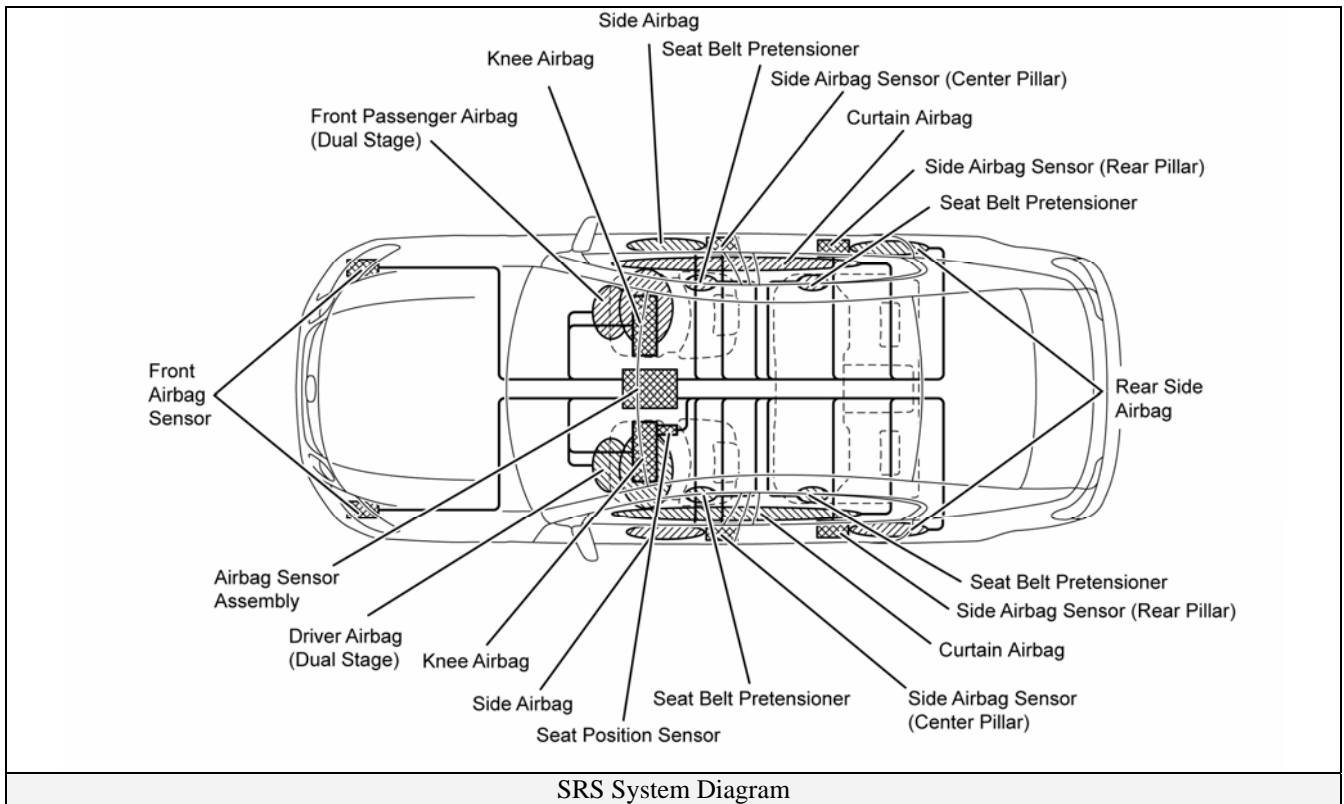

Emergency Response

On arrival, emergency responders should follow their standard operating procedures for vehicle incidents. Emergencies involving the GS450h may be handled like other automobiles except as noted in these guidelines for Extrication, Fire, Overhaul, Recovery, Spills, First Aid, and Submersion.

⚠ WARNING:

- *Never assume the GS450h is shut off simply because it is silent.*
- *Always observe the instrument cluster for the **READY** indicator status to verify whether the vehicle is on or shut off. The vehicle is shut off when the **READY** indicator is off.*
- *Failure to shut off the vehicle before emergency response procedures are performed may result in serious injury or death from the unintentional deployment of the SRS or severe burns and electric shock from the high voltage electrical system.*

Extrication

- **Immobilize Vehicle**
Chock wheels and set the parking brake.
Move the shift lever to the **Park** position.
- **Disable Vehicle**
Performing any one of the following three procedures will shut the vehicle off and disable the HV battery pack, SRS, and gasoline fuel pump.

Procedure #1

1. Confirm the status of **READY** indicator in the instrument cluster.
2. If the **READY** indicator is illuminated, the vehicle is on and operational. Shut off the vehicle by pushing the power button once.
3. The vehicle is already shut off if the instrument cluster lights and the **READY** indicator are not illuminated. Do **not** push the power button because the vehicle may start.
4. Keep the smart key at least 16 feet (5 meters) away from the vehicle.
5. If the smart key cannot be found, disconnect the 12-Volt auxiliary battery in the trunk.

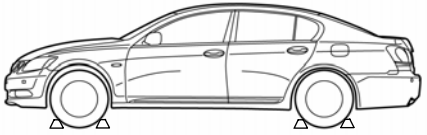
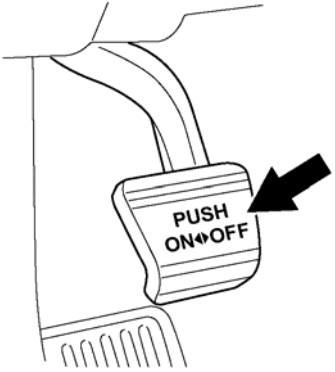
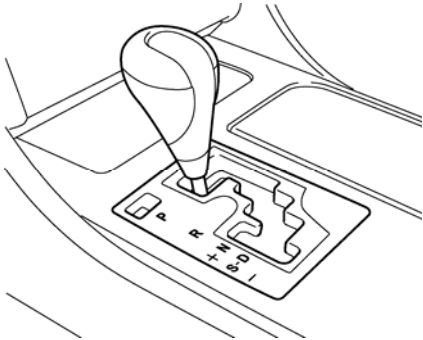
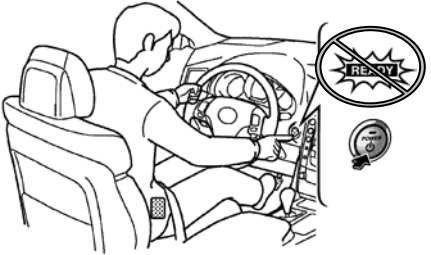
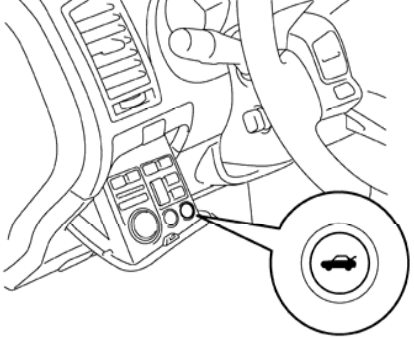
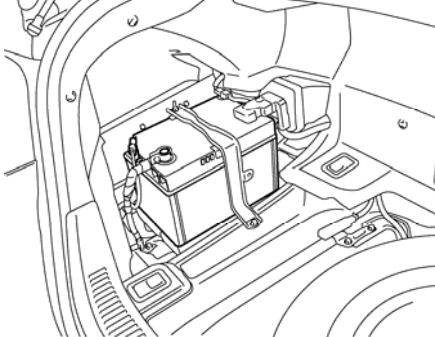
| | |
|---|---|
|  |  |
| Chock Wheels | Set Parking Brake |
|  |  |
| Shift Lever in Park | Shut Off Vehicle (READY-Off) |
|  |  |
| Trunk Opener Button | 12-Volt Auxiliary Battery in Trunk |

Emergency Response (Continued)

Extrication (Continued)

NOTE:

Before disconnecting the 12-Volt auxiliary battery, if necessary, reposition the power seats and tilt/telescoping steering wheel, lower the windows, unlock the doors, open the trunk and the fuel door as required. A manual fuel door release is located in the trunk (see illustration in the Roadside Assistance section page 25). Once the 12-Volt auxiliary battery is disconnected power controls will not operate.

Procedure #2 (Alternate if power button is inaccessible)

1. Disconnect the 12-Volt auxiliary battery in the trunk.
2. Remove the engine compartment covers.
3. Remove the driver side fuse box cover.
4. Remove the IGCT No. 1 fuse (20A yellow colored) in the engine compartment junction block as illustrated. If the correct fuse cannot be recognized, pull all of the fuses in the fuse block.

Procedure #3 (Alternate if power button and engine compartment are inaccessible)

1. Remove the RH J/B-B fuse (30A green colored) in the trunk near the auxiliary battery positive post as illustrated. If the correct fuse cannot be recognized, pull all three fuses.
2. Disconnect the 12-Volt auxiliary battery in the trunk.

⚠ WARNING:

- The high voltage system may remain powered for up to 10 minutes after the vehicle is shut off or disabled. To prevent serious injury or death from severe burns or electric shock, avoid touching, cutting, or opening any orange high voltage power cable or high voltage component.
- The SRS may remain powered for up to 90 seconds after the vehicle is shut off or disabled. To prevent serious injury or death from unintentional SRS deployment, avoid breaching the SRS components.
- If none of the disabling procedures can be performed, proceed with caution as there is no assurance that the high voltage electrical system, SRS, or fuel pump are disabled.

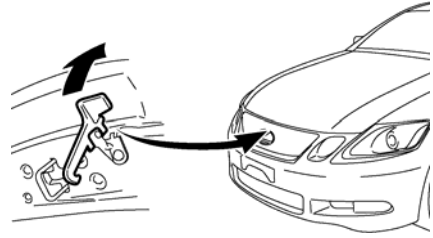
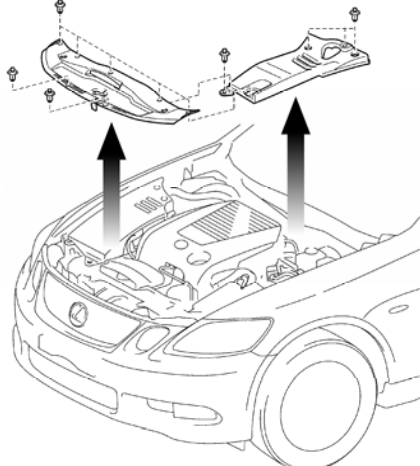
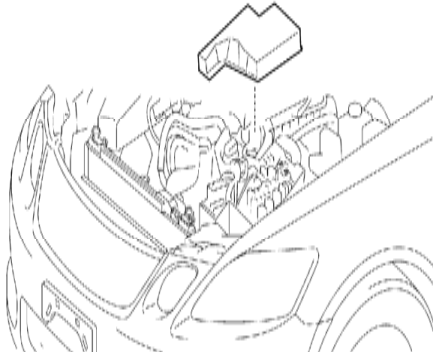
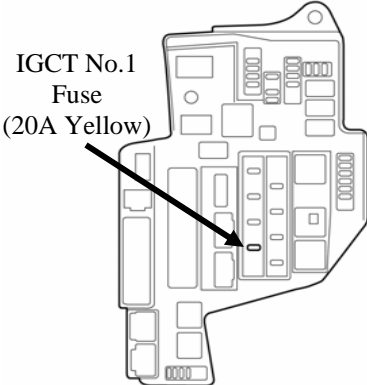
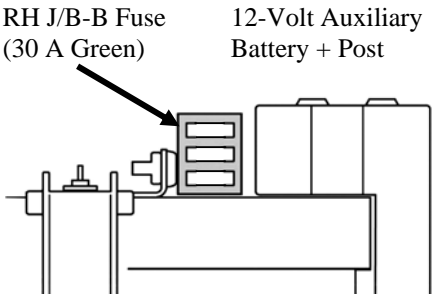
| | |
|--|--|
|  |  |
| <p>Remote Hood Release</p> | <p>Hood Latch Release</p> |
|  |  |
| <p>Remove Engine Compartment Covers</p> | <p>Remove Fuse Box Cover</p> |
|  <p>IGCT No.1 Fuse (20A Yellow)</p> |  <p>RH J/B-B Fuse (30 A Green) 12-Volt Auxiliary Battery + Post</p> |
| <p>IGCT No. 1 Fuse Location in Engine Compartment Fuse Box</p> | <p>RH J/B-B Fuse in Trunk near the Auxiliary Battery Positive Post</p> |

Emergency Response (Continued)

Extrication (Continued)

- Stabilize Vehicle

Crib at (4) points directly under the front and rear pillars.
Do not place cribbing under the high voltage power cables, exhaust system, or fuel system.

NOTES:

The GS450h is equipped with a tire pressure warning system that by design prevents pulling the metal valve stem with integral transmitter. Snapping the stem with pliers or removing the valve cap and Schrader valve will release the air in the tire.

The GS450h may also be equipped with optional run flat tires, having reinforced side walls that will support the vehicle's weight even when punctured, unlike conventional tires.

Unlike conventional tires, the run flat tire when deflated may only drop 1 inch (2.54 cm) due to the stiffness of the side wall. Like conventional tires, responders should not stab tires with a knife, doing so could cause serious injury to the hand.

- Access Patients

Glass Removal

Use normal glass removal procedures as required.

SRS Awareness

Responders need to be cautious when working in close proximity to undeployed airbags and seat belt pretensioners. Front dual stage airbags automatically ignite both stages within a fraction of a second.

Door Removal/Displacement

Doors can be removed by conventional rescue tools such as hand, electric, and hydraulic tools. In certain situations, it may be easier to pry back the vehicle body to expose and unbolt the hinges.

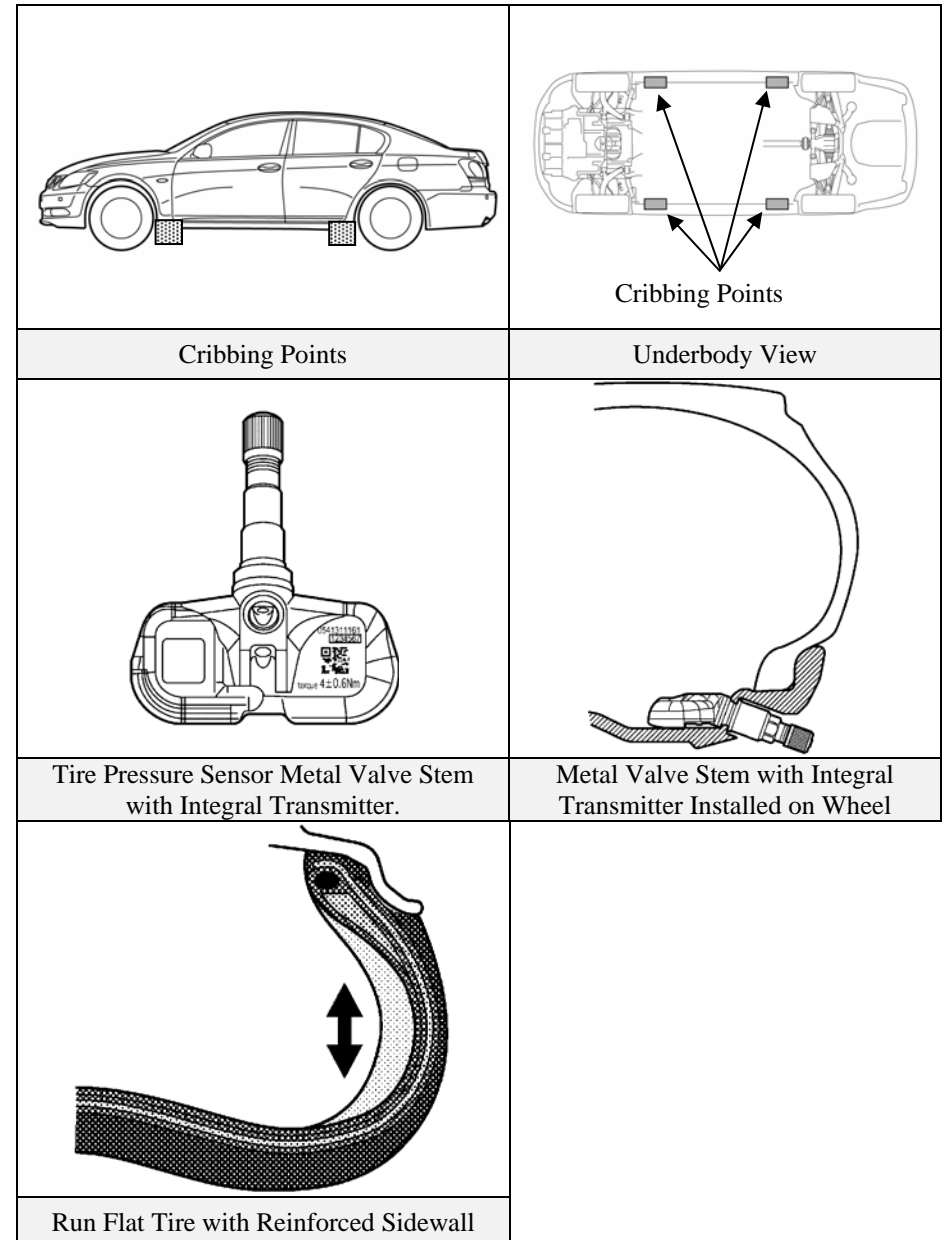

Emergency Response (Continued)

Extrication (Continued)

Roof Removal

The GS450h contains side curtain airbags. If undeployed, it is not recommended to remove or to displace the roof. The side curtain airbags may be identified as illustrated.

Dash Displacement

The GS450h contains side curtain airbags. Do not remove or displace the roof during a dash displacement to avoid cutting into undeployed airbags or inflators. As an alternative, dash displacement may be performed by using a Modified Dash Roll.

Rescue Lift Air Bags

Responders should not place cribbing or rescue lift air bags under the high voltage power cables, exhaust system, or fuel system.

Repositioning Steering Wheel and Seat

Power tilt/telescopic steering wheel and seat controls are shown in the illustration.

NOTE:

The GS450h driver seat is equipped with a power seat slide linked headrest. Repositioning the seat and/or headrest removal must be done prior to 12-Volt auxiliary battery disconnect. Unlike the passenger seat, the driver seat has a hidden release button located under the seat fabric as illustrated.

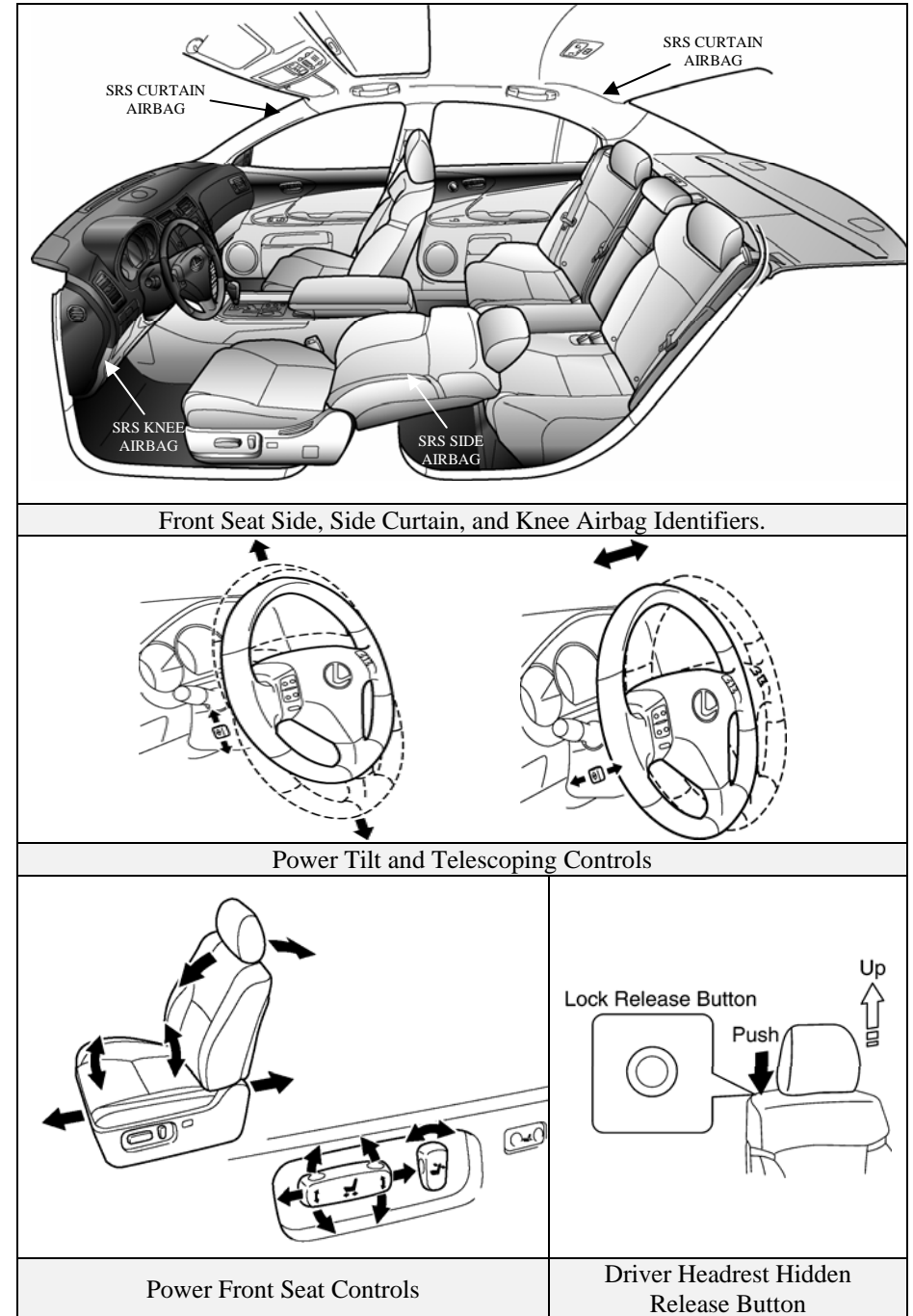

Emergency Response (Continued)

Fire

Approach and extinguish a fire using proper vehicle fire fighting practices as recommended by NFPA, IFSTA, or the National Fire Academy (USA).

- **Extinguishing Agent**
Water has been proven to be a suitable extinguishing agent.
- **Initial Fire Attack**
Perform a fast, aggressive fire attack.
Divert the runoff from entering watershed areas.
Attack teams may not be able to identify a GS450h until the fire has been knocked down and overhaul operations have commenced.
- **Fire in the HV Battery Pack**
Should a fire occur in the NiMH HV battery pack, attack crews should utilize a water stream or fog pattern to extinguish any fire within the trunk except for the HV battery pack.

WARNING:

- *The NIMH battery electrolyte is a caustic alkaline (pH 13.5) that is damaging to human tissues. To avoid injury by coming in contact with the electrolyte, wear proper personal protective equipment.*
- *The battery modules are contained within a metal case and accessibility is limited.*
- *To avoid serious injury or death from severe burns or electric shock, **never** breach or remove the high voltage battery pack cover under any circumstance including fire.*

When allowed to burn themselves out, the GS450h NiMH battery modules burn rapidly and can quickly be reduced to ashes except for the metal.

Offensive Fire Attack

Normally flooding a NiMH HV battery pack with copious amounts of water at a safe distance will effectively control the HV battery pack fire by cooling the adjacent NiMH battery modules to a point below their ignition temperature. The remaining modules on fire, if not extinguished by the water, will burn themselves out.

However, flooding the GS450h HV battery pack is not recommended due to the battery case design and location preventing the responder from properly applying water through the available vent openings safely. Therefore, it is recommended that the incident commander allow the GS450h HV battery pack to burn itself out.

Defensive Fire Attack

If the decision has been made to fight the fire using a defensive attack, the fire attack crew should pull back a safe distance and allow the NiMH battery modules to burn themselves out. During this defensive operation, fire crews may utilize a water stream or fog pattern to protect exposures or to control the path of smoke.

Overhaul

During overhaul, immobilize and disable the vehicle if not already done. See illustrations on page 17. The HV battery cover should **never** be breached or removed under any circumstances including fire. Doing so may result in severe electrical burns, shock, or electrocution.

- **Immobilize Vehicle**
Chock wheels and set the parking brake.
Move the shift lever to the **Park** position.
- **Disable Vehicle**
Performing any one of the following three procedures will shut the vehicle off and disable the HV battery pack, SRS, and gasoline fuel pump.

Emergency Response (Continued)

Overhaul (Continued)

Procedure #1

1. Confirm the status of **READY** indicator in the instrument cluster.
2. If the **READY** indicator is illuminated, the vehicle is on and operational. Shut off the vehicle by pushing the power button once.
3. The vehicle is already shut off if the instrument cluster lights and the **READY** indicator are not illuminated. Do **not** push the power button because the vehicle may start.
4. Keep the smart key at least 16 feet (5 meters) away from the vehicle.
5. If the smart key cannot be found, disconnect the 12-Volt auxiliary battery in the trunk.

Procedure #2 (Alternate if power button is inaccessible)

1. Disconnect the 12-Volt auxiliary battery in the trunk.
2. Remove the engine compartment covers.
3. Remove the driver side fuse box cover.
4. Remove the IGCT No. 1 fuse (20A yellow colored) in the engine compartment junction block as illustrated on page 18. If the correct fuse cannot be recognized, pull all of the fuses in the fuse block.

Procedure #3 (Alternate if power button and engine compartment are inaccessible)

1. Remove the RH J/B-B fuse (30A green colored) in the trunk near the auxiliary battery positive post as illustrated on page 18. If the correct fuse cannot be recognized, pull all three fuses.
2. Disconnect the 12-Volt auxiliary battery in the trunk.

Recovery/Recycling of NiMH HV Battery Pack

Clean up of the HV battery pack can be accomplished by the vehicle recovery crew without further concern of runoff or spillage. For information regarding recycling of the HV battery pack, contact the nearest Lexus dealer, or:

United States: (800) 255-3987, Canada: (800) 265-3987

WARNING:

- *The high voltage system may remain powered for up to 10 minutes after the vehicle is shut off or disabled. To prevent serious injury or death from severe burns or electric shock, avoid touching, cutting, or opening any orange high voltage power cable or high voltage component.*
- *The SRS may remain powered for up to 90 seconds after the vehicle is shut off or disabled. To prevent serious injury or death from unintentional SRS deployment, avoid breaching the SRS components.*
- *If none of the disabling procedures can be performed, proceed with caution as there is no assurance that the high voltage electrical system, SRS, or fuel pump are disabled.*

Spills

The GS450h contains the same common automotive fluids used in other non-hybrid Lexus vehicles, with the exception of NiMH electrolyte used in the HV battery pack. The NiMH battery electrolyte is a caustic alkaline (pH 13.5) that is damaging to human tissues. The electrolyte, however, is absorbed in the cell plates and will not normally spill or leak out even if a battery module is cracked. A catastrophic crash that would breach both the metal battery pack case and the plastic battery module would be a rare occurrence.

Similar to the use of baking soda to neutralize a lead-acid battery electrolyte spill, a dilute boric acid solution or vinegar can be used to neutralize a NiMH battery electrolyte spill.

NOTE:

Electrolyte leakage from the HV battery pack is unlikely due to its construction and the amount of available electrolyte contained within the NiMH modules. Any spillage would not warrant a declaration as a hazardous material incident. Responders should follow the recommendations as outlined in this emergency response guide.

Emergency Response (Continued)

Spills (Continued)

In an emergency, Lexus Material Safety Data Sheets (MSDS) are available by contacting:

United States: CHEMTREC at (800) 424-9300
Canada: CANUTEC at *666 or (613) 996-6666 (collect)

- Handle NiMH electrolyte spills using the following Personal Protective Equipment (PPE):
 - Splash shield or safety goggles. Fold down helmet shields are not acceptable for acid or electrolyte spills.
 - Rubber, latex or nitrile gloves.
 - Apron suitable for alkaline.
 - Rubber boots.
- Neutralize NiMH Electrolyte
 - Use a boric acid solution or vinegar.
 - Boric acid solution - 800 grams boric acid to 20 liters water or 5.5 ounces boric acid to 1 gallon of water.

First Aid

Emergency responders may not be familiar with a NiMH electrolyte exposure when rendering aid to a patient. Exposure to the electrolyte is unlikely except in a catastrophic crash or through improper handling. Utilize the following guidelines in the event of exposure.

WARNING:

The NIMH battery electrolyte is a caustic alkaline (pH 13.5) that is damaging to human tissues. To avoid injury by coming in contact with the electrolyte, wear proper personal protective equipment.

- Wear Personal Protective Equipment (PPE)
 - Splash shield or safety goggles. Fold down helmet shields are not acceptable for acid or electrolyte spills.
 - Rubber, latex or nitrile gloves.
 - Apron suitable for alkaline.
 - Rubber boots.

- Absorption
 - Perform gross decontamination by removing affected clothing and properly disposing of the garments.
 - Rinse the affected areas with water for 20 minutes.
 - Transport patients to the nearest emergency medical care facility.
- Inhalation in Non-Fire Situations
 - No toxic gases are emitted under normal conditions.
- Inhalation in Fire Situations
 - Toxic gases are given off as by-products of combustion. All responders in the Hot Zone should wear the proper PPE for fire fighting including SCBA.
 - Move a patient from the hazardous environment to a safe area and administer oxygen.
 - Transport patients to the nearest emergency medical care facility.
- Ingestion
 - Do not induce vomiting.
 - Allow a patient to drink large quantities of water to dilute electrolyte (Never give water to an unconscious person).
 - If vomiting occurs spontaneously, keep the patient's head lowered and forward to reduce the risk of asphyxiation.
 - Transport patients to the nearest emergency medical care facility.

Submersion

When fully or partially submersed a GS450h can be safely handled by following these recommendations:

- Remove the vehicle from the water.
- Drain the water from the vehicle if possible.
- Follow the immobilizing and disabling procedures on page 17.

Roadside Assistance

Lexus GS450h roadside assistance may be handled like conventional Lexus vehicles except as noted in the following pages.

Lexus Roadside Assistance is available during the basic warranty period by contacting:

United States: (800) 255-3987, Canada: (800) 265-3987

Shift Lever

Similar to most Lexus vehicles, the GS450h uses a gated shift lever as shown in the illustration. However, the GS450h shift lever includes an **S** position for 6 levels of engine braking.

Towing

The GS450h is a rear drive vehicle and it must be towed with the rear wheels off the ground. Failure to do so may cause serious damage to the Hybrid Synergy Drive components.

- A flat bed trailer is the preferred method of towing.
- When towing the vehicle with the front wheels on the ground, be sure to release the steering lock by turning the ignition-on.
- The vehicle may be shifted out of **Park** into **Neutral** by turning the ignition-on, depressing the brake, then moving the gated shift lever to **N**.
- If the shift lever cannot be moved out of **Park**, a shift lock release button is provided near the shift lever as shown in the illustration.
- If a tow truck is not available, in an emergency the vehicle may be temporarily towed using a cable or chain secured to the emergency towing eyelet. This should only be attempted on hard, paved roads for short distances at low speeds.

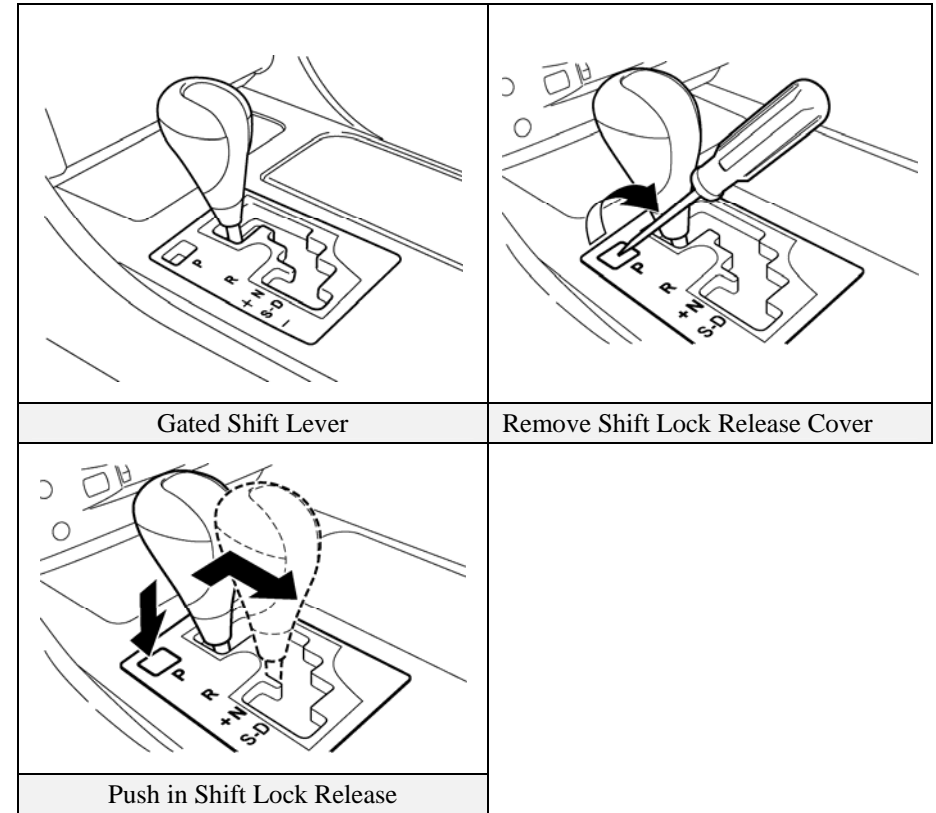

Roadside Assistance (Continued)

Electric Trunk Opener

The GS450h is equipped with an electric trunk opener. In the event of 12-Volt power loss, the trunk can be opened with the metal cut key hidden in the smart key.

Electric Fuel Door Opener

The GS450h is equipped with an electric fuel door opener. In the event of 12-Volt power loss, the fuel door can only be opened using the manual release located inside the trunk.

Spare Tire

The jack, tools, and spare tire are provided in the trunk as illustrated.

NOTE:

If the vehicle is equipped with the optional active stabilizer suspension system, the vehicle will not be equipped with a spare tire.

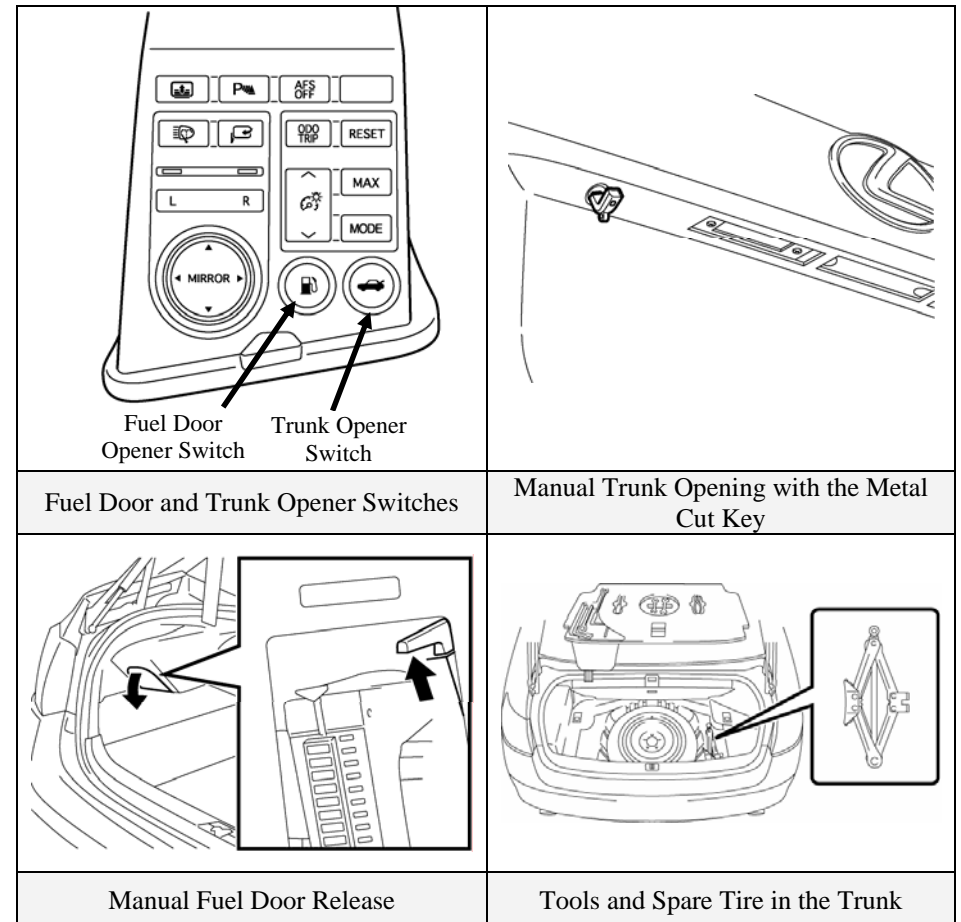

Roadside Assistance (Continued)

Jump Starting

The 12-Volt auxiliary battery may be jump started if the vehicle does not start and the instrument cluster gauges are dim or off after depressing the brake pedal and pushing the power button.

The 12-Volt auxiliary battery is located in the trunk. The trunk opener will not operate if the auxiliary battery is discharged. Instead use the metal cut key hidden in the smart key to open the trunk.

- Open the trunk, and remove the 12-Volt auxiliary battery cover on the driver side.
- Connect the positive jumper cable to the positive battery post.
- Connect the negative jumper cable to the negative battery post.
- Place the smart key in proximity to the vehicle, depress the brake pedal, and push the power button.

NOTES:

If the vehicle does not recognize the smart key after connecting the booster battery to the vehicle, open and close the driver door when the vehicle is shut off.

If the smart key internal battery is dead, hold the smart key next to the power button during the start sequence.

- The high voltage HV battery pack cannot be jump started.

Immobilizer & Anti-Theft Alarm

The GS450h is equipped with an immobilizer system and an anti-theft alarm as standard equipment.

- The vehicle can be started only with a registered smart key.
- To disarm the anti-theft alarm, unlock the door by using the smart key button, hidden metal cut key, or using the door handle touch sensor. Engaging the ignition-on mode or starting the vehicle will also disarm the anti-theft alarm.

