

Introduction

This manual explains the operation of the Display Audio system. Please read this manual carefully to ensure proper use. Keep this manual in your vehicle at all times.

The screen shots in this document and the actual screens of the Display Audio system differ depending on whether the functions and/or a contract existed at the time of producing this document.

TOYOTA MOTOR CORPORATION

IMPORTANT INFORMATION ABOUT THIS MANUAL

For safety reasons, this manual indicates items requiring particular attention with the following marks.



CAUTION

- This is a warning against anything which may cause injury to people if the warning is ignored. You are informed about what you must or must not do in order to reduce the risk of injury to yourself and others.



NOTICE

- This is a warning against anything which may cause damage to the vehicle or its equipment if the warning is ignored. You are informed about what you must or must not do in order to avoid or reduce the risk of damage to your vehicle and its equipment.

SAFETY INSTRUCTION

To use this system in the safest possible manner, follow all the safety tips shown below.

Do not use any feature of this system to the extent it becomes a distraction and prevents safe driving. The first priority while driving should always be the safe operation of the vehicle. While driving, be sure to observe all traffic regulations.

Prior to the actual use of this system, learn how to use it and become thoroughly familiar with it. Read the entire Display Audio system Owner's manual to make sure you understand the system. Do not allow other people to use this system until they have read and understood the instructions in this manual.

For your safety, some functions may become inoperable when driving. Unavailable screen buttons are dimmed.



CAUTION

- For safety, the driver should not operate the Display Audio system while he/she is driving. Insufficient attention to the road and traffic may cause an accident.

1. OVERVIEW BUTTONS

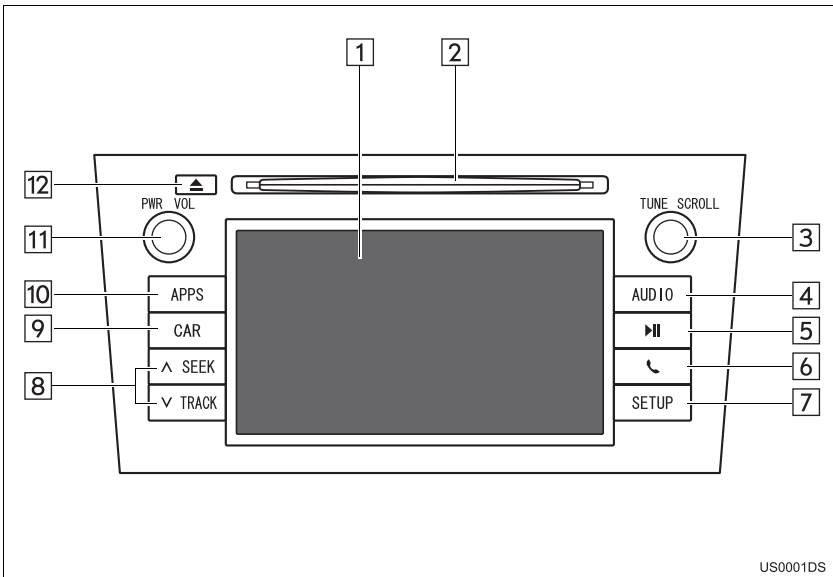

US0001DS

● The actual design and button position may differ depending on the vehicle. For details, see Section 3 of the vehicle *“Owner’s Manual”*.

No.	Name	Function	Page
1	Touch screen display	By touching the screen with your finger, you can control the selected functions.	11
2	Disc slot	Insert a disc into this slot. The CD player turns on immediately.	34
3	“TUNE/SCROLL” knob	Turn this knob to select radio station bands, tracks and files. Also, the knob can be used for selection from the list display.	16
4	“AUDIO” button	Press this button to access the audio system. The audio system turns on in the last mode used.	14, 16, 17
5	▶ button*	Press this button to pause or resume playing the music.	—
6	📞 button	Press this button to access the Bluetooth® hands-free system.	68
7	“SETUP” button	Press this button to customize the function settings.	92
8	“SEEK/TRACK” button	Press the “^” or “v” button to seek up or down for a radio station, or to access a desired track or file.	21, 24, 31, 36, 37, 41, 44, 54

No.	Name	Function	Page
9	"CAR" button*	Press this button to access the vehicle information system.	86
10	"APPS" button*	This button is used for an add-on external navigation system. (If equipped)	—
11	"PWR/VOL" knob	Press this knob to turn the audio system on and off, and turn it to adjust the volume.	16
12	 button	Press this button to eject a disc.	34

*: If equipped

2. SYSTEM FUNCTION INDEX

AUDIO SYSTEM

To access the audio system, press the **“AUDIO”** button. The audio control screen will be displayed. Audio sources: Radio, CDs, iPod, USB, AUX and Bluetooth® audio. For details, see pages 13.

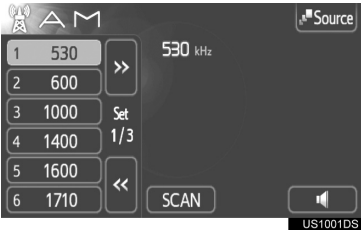

US1001DS

Bluetooth® HANDS-FREE SYSTEM

To access the Bluetooth® hands-free system, press the  button. The driver can make or receive phone calls without taking their hands off the steering wheel. For details, see pages 67.

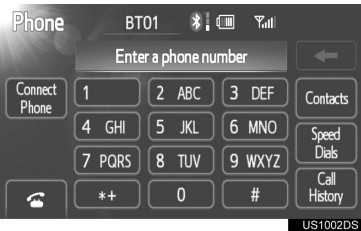

US1002DS

VEHICLE INFORMATION (IF EQUIPPED)

To access the vehicle information system, press the **“CAR”** button. Fuel consumption and tire pressure can be checked. For details, see pages 85.

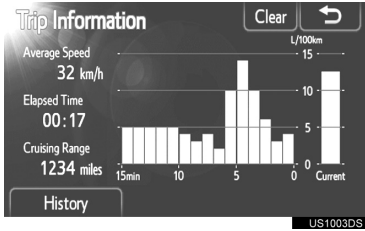

US1003DS

SETUP

To customize the function settings, press the **“SETUP”** button. The interface language can also be changed from the setup menu. For details, see page 91.



US5056DS

REAR VIEW MONITOR SYSTEM

Shifting into the **“R”** position will automatically show the view behind the rear of the vehicle on the display screen. For details, see page 119.



US1006DS

3. TOUCH SCREEN OPERATION

This system is operated mainly by the screen buttons.

- To prevent damage to the screen, lightly touch the screen buttons with your finger. When a screen button is touched, a beep sounds. (To set a beep sound, see page 93.)
- Do not use objects other than your finger to touch the screen.



NOTICE

- To prevent the 12-volt battery from being discharged, do not leave the system on longer than necessary when the engine is not running.

INFORMATION

- If the system does not respond to a touch on a screen button, move your finger away from the screen and then touch it again.
- Dimmed screen buttons cannot be operated.
- Wipe off fingerprints using a glass cleaning cloth. Do not use chemical cleaners to clean the touch screen.
- The displayed image may become darker and moving images may be slightly distorted when the display is cold.
- Under extremely cold conditions, the screen may not be displayed and the data input by a user may be deleted. Also, the screen buttons may be harder than usual to depress.
- When you look at the screen through polarized material such as polarized sunglasses, the screen may be dark and hard to see. If so, look at the screen from different angles, adjust the screen settings (See "DISPLAY SETTINGS" on page 96.), or take off your sunglasses.

1. AUDIO SYSTEM OPERATION

1. QUICK REFERENCE

To access the audio system, press the **“AUDIO”** button. The audio system turns on in the last mode used.

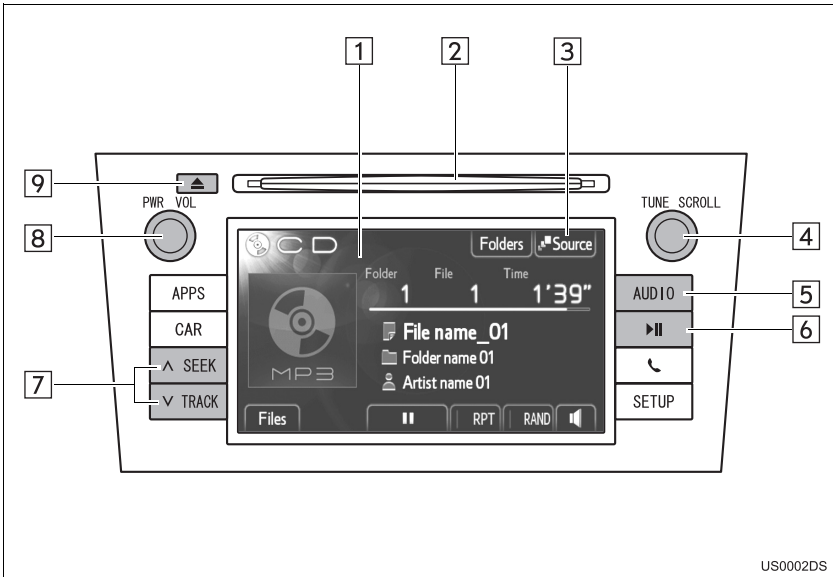

US0002DS

- The actual design and button position may differ depending on the vehicle. For details, see Section 3 of the vehicle *“Owner’s Manual”*.

No.	Name	Function	Page
1	Audio control screen	A selected audio source is displayed, and it can be operated with the touch screen controls.	—
2	Disc slot	Insert a disc into this slot. The CD player turns on immediately.	34
3	“Source”	Touch to select your desired audio sources. The audio source selection screen will be displayed.	17
4	“TUNE/SCROLL” knob	Turn to select radio station bands, tracks and files. Also, the knob can be used for selection from the list display.	16
5	“AUDIO” button	Press to display the audio control screen. The audio system turns on in the last mode used.	16, 17
6	▶ button*	Press to pause or resume playing the music.	—
7	“SEEK/TRACK” button	Press the “^” or “v” button to seek up or down for a station, or to access a desired track or file.	21, 24, 31, 36, 37, 41, 44, 54

No.	Name	Function	Page
8	"PWR/VOL" knob	Press to turn the audio system on and off, and turn to adjust the volume.	16
9	 button	Press to eject a disc.	34

*: If equipped

1. AUDIO SYSTEM OPERATION

2. SOME BASICS

This section describes some of the basic features of the audio system. Some information may not pertain to your system.

Your audio system works when the engine switch is turned to the “ACC” or “ON” position.

⚠ CAUTION

- For vehicles sold in U.S.A. and Canada: Part 15 of the FCC Rules
FCC Warning: Changes or modifications in construction not expressly approved by the party responsible for compliance could void the user’s authority to operate the equipment. Radio frequency exposure. This device is approved for Mobile Application only and, to comply with applicable FCC radio frequency exposure regulations, must be used with a distance of at least 7.9 in. (20 cm) between the antenna and the body of any person at all time during use.
- Laser products
 - Do not take this unit apart or attempt to make any changes yourself. This is an intricate unit that uses a laser pickup to retrieve information from the surface of compact discs. The laser is carefully shielded so that its rays remain inside the cabinet. Therefore, never try to disassemble the player or alter any of its parts since you may be exposed to laser rays and dangerous voltages.
 - This product utilizes a laser. Use of controls or adjustments or performance of procedures other than those specified herein may result in hazardous radiation exposure.

⚠ NOTICE

- To prevent the 12-volt battery from being discharged, do not leave the audio system on longer than necessary when the engine is not running.

TURNING THE AUDIO SYSTEM ON OR OFF

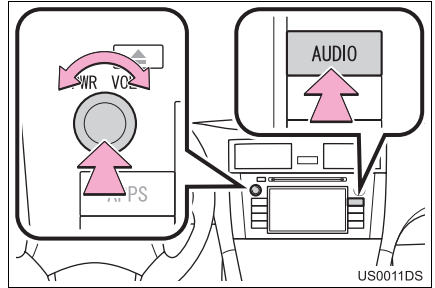

“AUDIO” button: Press this button to display screen buttons for the audio system.

“PWR/VOL” knob: Press this knob to turn the audio system on and off. Turn this knob to adjust the volume. The system turns on in the last mode used.

INFORMATION

- If the volume is adjusted while music is paused or muted, the pause or mute will be cancelled.

CONTROLS USING THE “TUNE/SCROLL” KNOB

- ▶ Radio mode
Radio stations can be tuned in manually using this knob.
- ▶ Modes other than radio
Tracks or files can be selected using the knob.

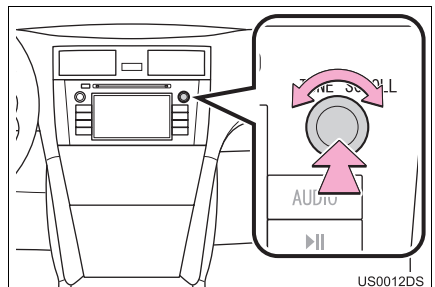

► When a list is displayed

When a list is displayed on the screen, turn the “TUNE/SCROLL” knob to move the cursor box to select a desired item from the list, and pressing the knob will play it. The track that is being played is highlighted.



SWITCHING AUDIO SOURCE

1 Press the “AUDIO” button.

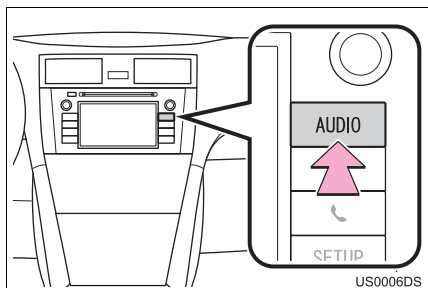

- The audio system turns on in the last mode used.

2 Touch “Source” or press “AUDIO” button to display the audio source selection screen.



3 Touch a desired audio source.



- If a desired source is not displayed on the screen, touch or to scroll to it.
- Touching the “ALL” will change the list style as follows.



INFORMATION

- You cannot select dimmed screen buttons. Connect the audio device before selecting.

DSP CONTROL

1 Press the “AUDIO” button.

2 Touch .



3 Touch the “**DSP**” tab to display this screen.

▶ Without JBL sound system

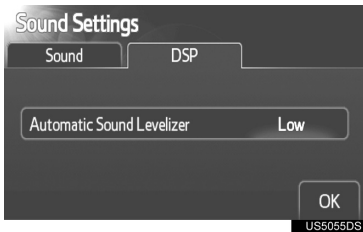

▶ With JBL sound system

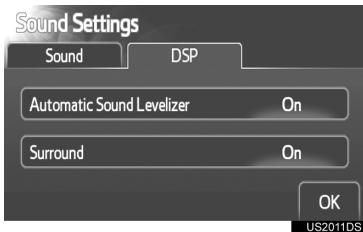

4 Touch the desired screen button.

AUTOMATIC SOUND LEVELIZER (ASL)

The system adjusts to the optimum volume and tone quality according to vehicle speed to compensate for increased vehicle noise.

▶ Without JBL sound system

1 Touch “**High**”, “**Mid**” or “**Low**” of “Automatic Sound Levelizer”.

2 Touch “**OK**”.

▶ With JBL sound system

1 Touch “**On**” of “Automatic Sound Levelizer”.

2 Touch “**OK**”.

SURROUND FUNCTION (IF EQUIPPED)

1 Touch “**On**” of “Surround”.

2 Touch “**OK**”.

STONE AND BALANCE

STONE

How good an audio program sounds is largely determined by the mix of the treble, mid and bass levels. In fact, different kinds of music and vocal programs usually sound better with different mixes of treble, mid and bass.

BALANCE

A good balance of the left and right stereo channels and of the front and rear sound levels is also important.

Keep in mind that when listening to a stereo recording or broadcast, changing the right/left balance will increase the volume of one group of sounds while decreasing the volume of another.

1 Press the “**AUDIO**” button.

2 Touch .



- 3** Touch the **“Sound”** tab to display this screen.

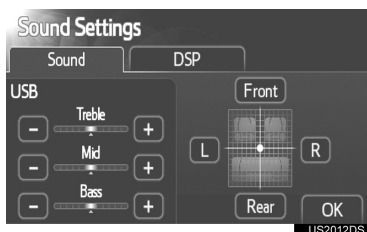

- 4** Touch the desired screen button.

“Treble” “+” or “-”: To adjust high-pitched tones.

“Mid” “+” or “-”: To adjust mid-pitched tones.

“Bass” “+” or “-”: To adjust low-pitched tones.

“Front” or “Rear”: To adjust the sound balance between the front and rear speakers.

“L” or “R”: To adjust the sound balance between the left and right speakers.

- 5** Touch **“OK”**.

INFORMATION

- The tone of each mode (such as AM, FM and CD player) can be adjusted.

3. RADIO OPERATION (WITH Display Audio SYSTEM)

SWITCHING TO RADIO MODE

1 Press the “AUDIO” button.

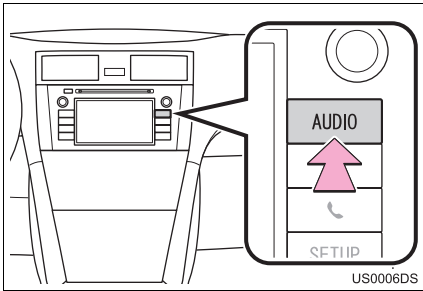



• The audio system turns on in the last mode used.

2 Touch “Source” or press “AUDIO” button to display the audio source selection screen.



3 Touch “AM” or “FM” on the screen.



• If a desired source is not displayed on the screen, touch  or  to scroll to it.

PRESETTING A STATION

1 Tune in the desired station.

2 Touch one of the left side screen buttons (1-6) and hold it until a beep is heard. This sets the preset frequency to the screen button. The station's frequency will be displayed in the screen button.

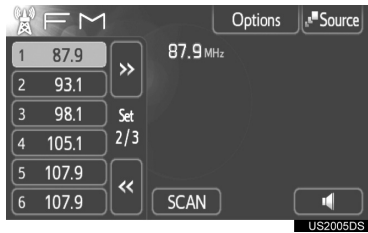

• To change the preset station to a different one, follow the same procedure.

• Touch  or  to change the preset page.

SELECTING A STATION

Tune in the desired station using one of the following methods.

Preset tuning: Touch one of the preset channels on the left side of the screen to select the desired station. The screen button is highlighted and the station frequency appears on the screen.

Manual tuning: Search for a desired radio station by turning the “**TUNE/SCROLL**” knob.

Seek tuning: Press the “**^**” or “**v**” button of “**SEEK/TRACK**”. The radio will begin seeking up or down for a station of the nearest frequency and will stop when a station is found. Each time the button is pressed, the stations will be searched automatically one after another.

To scan all the frequencies: Touch “**SCAN**”. “**SCAN**” will appear on the screen. The radio will find the next station and stay there for a few seconds, and then scan again. To stay tuned to a station and stop the scanning, touch “**SCAN**” again.

RADIO BROADCAST DATA SYSTEM

This audio system is equipped with Radio Broadcast Data Systems (RBDS). RBDS mode allows text messages to be received from radio stations that utilize RBDS transmitters.

When RBDS is on, the radio can

- only select stations of a particular program type,
- display messages from radio stations,
- search for a stronger signal station.

RBDS features are available only when listening to an FM station that broadcasts RBDS information and the “**FM info**” indicator is on.

SELECTING A DESIRED TYPE

1 Touch “**Options**”.



- 2** Touch “**TYPE >**” or “**< TYPE**” to move forward and backward through the program list.

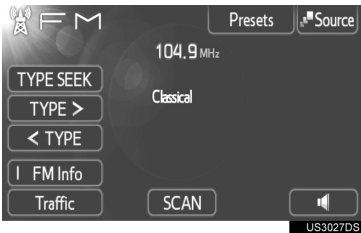

- Once a program type has been set, “TYPE SEEK” will appear on the screen.
- The program list is in the following order:
 - Classical
 - Country
 - EasyLis (Easy Listening)
 - Inform (Information)
 - Jazz
 - News
 - Oldies
 - Other
 - Pop Music
 - Religion
 - Rock
 - R&B (Rhythm and Blues)
 - Sports
 - Talk
 - Alert (Emergency Alert)

- 3** Touch “**TYPE SEEK**” and the system will start to seek for stations in the relevant program type.

INFORMATION

- If no relevant program can be found, “no type” will appear on the screen.

TRAFFIC ANNOUNCEMENT

A station that regularly broadcasts traffic information is automatically located.



“**Traffic**”: Touch to seek a traffic program station. “TRAF SEEK” will appear on the screen.

INFORMATION

- If no traffic program station is found, “No Traffic” will appear on the screen.
- If a traffic program station is found, the name of the traffic program station will be displayed for a while.

4. RADIO OPERATION (WITH Premium Display Audio SYSTEM)

SWITCHING TO RADIO MODE

- 1 Press the “AUDIO” button.

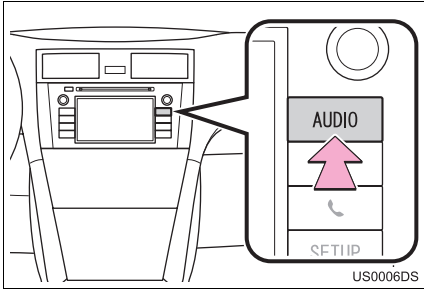

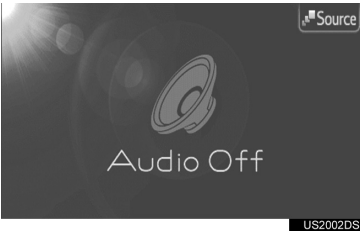

- The audio system turns on in the last mode used.

- 2 Touch “Source” or press “AUDIO” button to display the audio source selection screen.

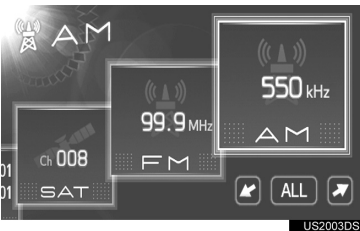

- 3 Touch “AM” or “FM” on the screen.





- If a desired source is not displayed on the screen, touch  or  to scroll to it.

PRESETTING A STATION

Radio mode has a mix preset function, which can store up to 36 stations (6 station per page × 6 page) from any of the AM, FM or SAT bands.

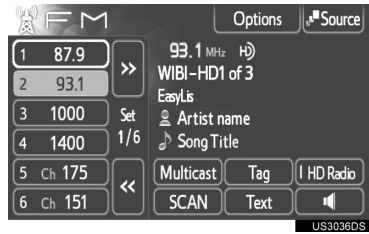
- 1 Tune in the desired station.
- 2 Touch one of the left side screen buttons (1-6) and hold it until a beep is heard. This sets the frequency to the screen button. The station's frequency will be displayed in the screen button.



- To change the preset station to a different one, follow the same procedure.
- Touch  or  to change the preset page.

SELECTING A STATION

Tune in the desired station using one of the following methods.

Preset tuning: Touch one of the mix preset channels on the left side of the screen to select the desired station. The screen button is highlighted and the station frequency appears on the screen.

Manual tuning: Search for a desired radio station by turning the “**TUNE/SCROLL**” knob.

Seek tuning: Press the “**^**” or “**v**” button of “**SEEK/TRACK**”. The radio will begin seeking up or down for a station of the nearest frequency and will stop when a station is found. Each time the button is pressed, the stations will be searched automatically one after another.

To scan all the frequencies: Touch “**SCAN**”. “**SCAN**” will appear on the screen. The radio will find the next station and stay there for 10 seconds if “**All**” or “**HD Only**” is selected, or 5 seconds if “**Analog**” is selected, and then scan again. To stay tuned to a station and stop the scanning, touch “**SCAN**” again. (To set the HD Radio™ system, see page 116.)

RADIO BROADCAST DATA SYSTEM

This audio system is equipped with Radio Broadcast Data Systems (RBDS). RBDS mode allows text messages to be received from radio stations that utilize RBDS transmitters.

When RBDS is on, the radio can

- only select stations of a particular program type,
- display messages from radio stations,
- search for a stronger signal station.

RBDS features are available only when listening to an FM station that broadcasts RBDS information and the “FM info” indicator is on.

SELECTING A DESIRED TYPE

1 Touch “Options”.

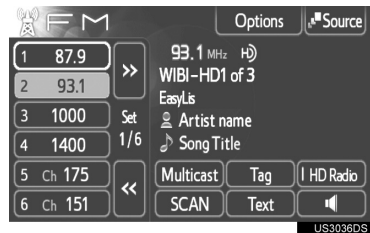

- 2 Touch “**TYPE >**” or “**< TYPE**” to move forward and backward through the program list.

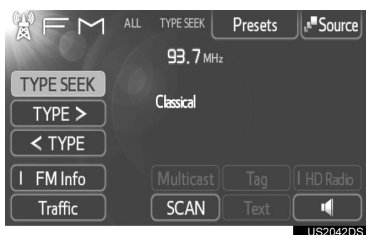

- Once a program type has been set, “TYPE SEEK” will appear on the screen.
- The program list is in the following order:
 - Classical
 - Country
 - EasyLis (Easy Listening)
 - Inform (Information)
 - Jazz
 - News
 - Oldies
 - Other
 - Pop Music
 - Religion
 - Rock
 - R&B (Rhythm and Blues)
 - Sports
 - Talk
 - Traffic (Not available when “HD Radio™ Settings” are set to analog)
 - Alert (Emergency Alert)

- 3 Touch “**TYPE SEEK**” and the system will start to seek for stations in the relevant program type.

INFORMATION

- If no relevant program can be found, “no type” will appear on the screen.

TRAFFIC ANNOUNCEMENT

A station that regularly broadcasts traffic information is automatically located.

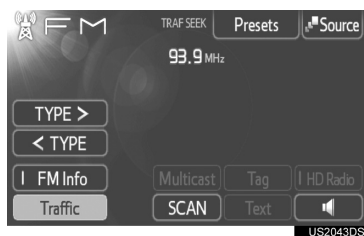

“**Traffic**”: Touch to seek a traffic program station. “TRAF SEEK” will appear on the screen.

INFORMATION

- If no traffic program station is found, “No Traffic” will appear on the screen.
- If a traffic program station is found, the name of the traffic program station will be displayed for a while.

USING HD Radio™ TECHNOLOGY

HD Radio™ Technology is the digital evolution of analog AM/FM radio. Your radio product has a special receiver which allows it to receive digital broadcasts (where available) in addition to the analog broadcasts it already receives. Digital broadcasts have better sound quality than analog broadcasts as digital broadcasts provide free, crystal clear audio with no information, and a guide to available radio stations and programming, refer to www.hdradio.com.

- 1 Touch “**HD Radio**” to turn the indicator on.

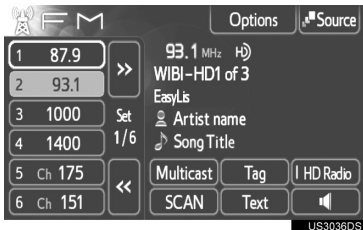

- As a user works through the analog radio stations, (where applicable) the radio receiver will automatically tune from an analog signal to a digital signal within 5 seconds.
- An orange “HD” logo indicator will be displayed on the screen when in digital. The “HD” logo will first appear in a gray color indicating the station is indeed (an analog and) a digital station. Once the digital signal is acquired, the logo will change to a bright orange color.

INFORMATION

- 1 Touch “**Text**”.

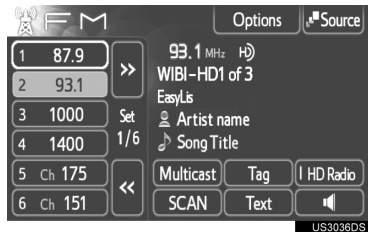

- 2 Information such as the artist name, song title, album title and music genre being listened to are displayed on the text screen.

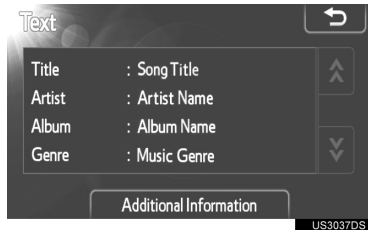

- To display messages from the station, touch “**Additional information**”.

MULTICAST

On the FM radio frequency most digital stations have “multiple” or supplemental programs on the FM station.

- 1 Touch “**Multicast**”.

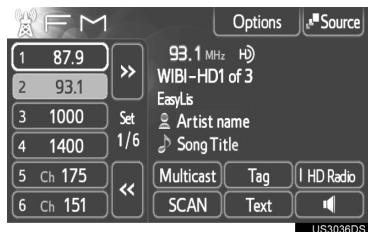

- Each time “**Multicast**” is touched, the supplemental program changes.
- If “**Multicast**” is touched when tuned to the last of the supplemental programs, the main program will be returned to.

TAG

- 1 Touch “Tag” to bookmark the music information.



- 2 Open the cover and connect iPod using an iPod cable.

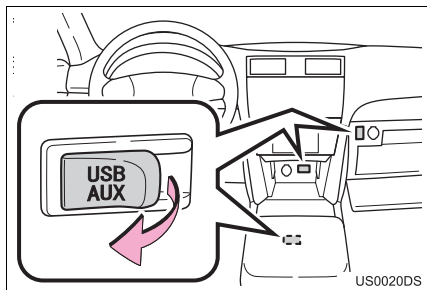

- The USB/AUX port is located on the instrument panel, or in the console box or glove box etc. The location and design are different depending on the vehicle. For details, see the Pictorial index of the vehicle “Owner’s Manual”.
- Turn on the power of the iPod if it is not turned on.
- Once an iPod is connected, the music tag moves from the radio into the iPod.
- When the iPod is connected to iTunes, the “tagged” information of the songs which were tagged while listening to the radio can be viewed. Then a user may decide to purchase the song or CD/Album which has been listened to on their radio.

INFORMATION

- If tagging the music information fails, “Saving the HD Radio tag failed.” will be displayed on the screen. If this occurs, tag the information again.
- HD Radio™ stations can be preset.

TROUBLESHOOTING GUIDE

Experience	Cause	Action
Mismatch of time alignment a users may hear a short period of programming re-played or an echo, stutter or skip.	The radio stations analog and digital volume is not properly aligned or the station is in ballgame mode.	None, radio broadcast issue. A user can contact the radio station.
Sound fades, blending in and out.	Radio is shifting between analog and digital audio.	Reception issue, may clear-up as the vehicle continues to be driven. Touching "HD Radio" with the indicator off can force radio in an analog audio.
Audio mute condition when an HD2/HD3 multicast channel has been playing.	The radio does not have access to digital signals at the moment.	This is normal behavior, wait until the digital signal returns. If out of the coverage area, seek a new station.
Audio mute delay when selecting an HD2/HD3 multicast channel preset.	The digital multicast content is not available until HD Radio™ broadcast can be decoded and make the audio available. This takes up to 7 seconds.	This is normal behavior, wait for the audio to become available.
Text information does not match the present song audio.	Data service issue by the radio broadcaster.	Broadcaster should be notified. Complete the form; www.ibiquity.com/automotive/report_radio_station_experiences .
No text information shown for the present selected frequency.	Data service issue by the radio broadcaster.	Broadcaster should be notified. Complete the form; www.ibiquity.com/automotive/report_radio_station_experiences .



HD Radio Technology manufactured under license from iBiquity Digital Corporation. U.S. and Foreign Patents. HD Radio™ and the HD, HD Radio, and "Arc" logos are proprietary trademarks of iBiquity Digital Corp.

5. RADIO OPERATION (XM[®] Satellite Radio BROADCAST)*HOW TO SUBSCRIBE TO AN XM[®] Satellite Radio

To listen to a satellite radio broadcast in the vehicle, a subscription to the XM[®] Satellite Radio service is necessary.

An XM[®] Satellite Radio is a tuner designed exclusively to receive broadcasts provided under a separate subscription. Availability is limited to the 48 contiguous U.S. states and some Canadian provinces.

HOW TO SUBSCRIBE

It is necessary to enter into a separate service agreement with XM[®] Satellite Radio in order to receive satellite broadcast programming in the vehicle. Additional activation and service subscription fees apply that are not included in the purchase price of the vehicle and digital satellite tuner.

- For complete information on subscription rates and terms, or to subscribe to XM[®] Satellite Radio:
 - ▶ U.S.A.
Refer to www.siriusxm.com or call 1-800-967-2346.
 - ▶ Canada
Refer to www.xmradio.ca or call 1-877-209-0079.

INFORMATION

- XM[®] Satellite Radio is solely responsible for the quality, availability and content of the satellite radio services provided, which are subject to the terms and conditions of the XM[®] Satellite Radio customer service agreement.
- Customers should have their radio ID ready; the radio ID can be found by tuning to “channel 000” on the radio. For details, see “DISPLAYING THE RADIO ID” below.
- All fees and programming are the responsibility of XM[®] Satellite Radio and are subject to change.

SATELLITE TUNER TECHNOLOGY NOTICE

Toyota’s satellite radio tuners are awarded Type Approval Certificates from XM[®] Satellite Radio Inc. as proof of compatibility with the services offered by XM[®] Satellite Radio.

DISPLAYING THE RADIO ID

Each XM[®] tuner is identified with a unique radio ID. The radio ID is required when activating an XM[®] service or when reporting a problem.

- If “CH 000” is selected using the “TUNE/SCROLL” knob, the ID code, which is 8 alphanumeric characters, will be displayed. If another channel is selected, the ID code will no longer be displayed. The channel (000) displays the radio ID and the specific radio code.

*: If equipped

SWITCHING TO SATELLITE RADIO MODE

1 Press the **"AUDIO"** button.

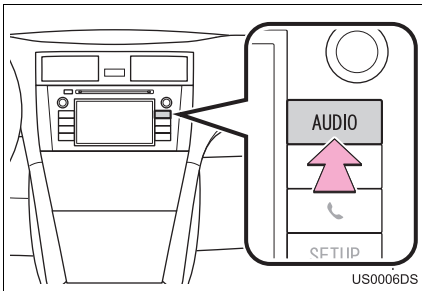



- The audio system turns on in the last mode used.

2 Touch **"Source"** or press **"AUDIO"** button to display the audio source selection screen.



3 Touch **"SAT"** on the screen.



- If a desired source is not displayed on the screen, touch  or  to scroll to it.

CHANNEL CATEGORY

1 Touch **"Options"**.

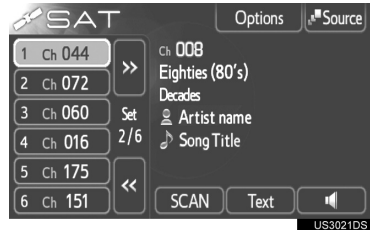

2 Touch either **"TYPE >"** or **"< TYPE"** to go to the next or previous category.

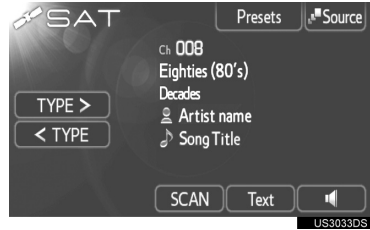

PRESETTING A CHANNEL

1 Tune in the desired channel.

2 Touch one of the left side screen buttons **(1-6)** and hold it until a beep is heard. This sets the preset frequency to the screen button. The Channel number will be displayed in the screen button.

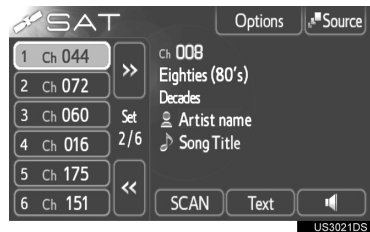

- To change the preset channel to a different one, follow the same procedure.

SELECTING A CHANNEL

Tune in the desired channel using one of the following methods.

Preset tuning: Touch the channel selector screen button (1-6) to listen to the desired channel. The selected screen button (1-6) is highlighted and its related information appears on the right side of the screen.

Manual tuning: Turn the “TUNE/SCROLL” knob to select the next or previous channel. Turning the knob quickly allows rapid scrolling through the channel list.

To select a channel within the current category: Press the “^” or “v” button of “SEEK/TRACK”. The radio will change up or down to a channel within the current channel category.

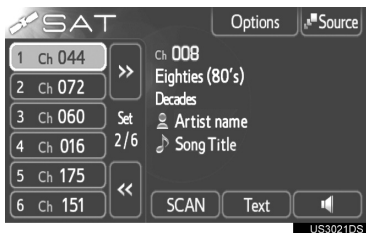

To scan the currently selected channel category: Touch “SCAN”. “SCAN” appears on the screen. The radio will find the next channel in the same channel category, stay there for a few seconds, and then scan again. To select a channel, touch “SCAN” again.

DISPLAYING THE TITLE AND NAME

- 1 Touching “Text” displays the artist name and song title you are currently listening to.

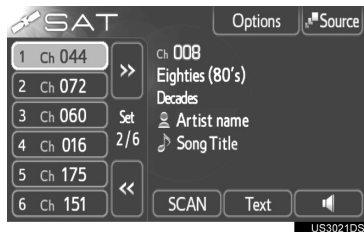

INFORMATION

- Up to 64 alphanumeric characters can be displayed. (Some information will not be fully displayed.)

IF THE SATELLITE RADIO TUNER MALFUNCTIONS

When problems occur with the XM[®] tuner, a message will appear on the screen. Referring to the table below to identify the problem, take the suggested corrective action.

Message	Explanation
Ck Antenna	The XM [®] antenna is not connected. Check whether the XM [®] antenna cable is attached securely.
	A short circuit occurs in the antenna or the surrounding antenna cable. See a Toyota certified dealer for assistance.
Ch Unauth	You have not subscribed to XM [®] Satellite Radio. The radio is being updated with the latest encryption code. Contact XM [®] Satellite Radio for subscription information. When a contract is canceled, you can choose "CH000" and all free-to-air channels.
	The premium channel you selected is not authorized. Wait for about 2 seconds until the radio returns to the previous channel or "CH001". If it does not change automatically, select another channel. To listen to the premium channel, contact XM [®] Satellite Radio.
No Signal	The XM [®] signal is too weak at the current location. Wait until your vehicle reaches a location with a stronger signal.
Loading	The unit is acquiring audio or program information. Wait until the unit has received the information.
Ch Off Air	The channel you selected is not broadcasting any programming. Select another channel.
-----	There is no song/program title or artist name/feature associated with the channel at that time. No action is required.
Ch Unavail	The channel you selected is no longer available. Wait for about 2 seconds until the radio returns to the previous channel or "CH001". If it does not change automatically, select another channel.

INFORMATION

- Contact the XM[®] Listener Care Center at 1-800-967-2346 (U.S.A.) or 1-877-209-0079 (Canada).

**NOTICE**

- This equipment has been tested and found to comply with the limits for a class B digital device, pursuant to Part 15 of the FCC Rules. These limits are designed to provide reasonable protection against harmful interference in a residential installation. This equipment generates, uses and can radiate radio frequency energy and, if not installed and used in accordance with the instructions, may cause harmful interference to radio communications. However, there is no guarantee that interference will not occur in a particular installation.
- If this equipment does cause harmful interference to radio or television reception, which can be determined by turning the equipment off and on, the user is encouraged to try to correct the interference by one or more of the following measures:
 - Reorient or relocate the receiving antenna.
 - Increase the separation between the equipment and receiver.
 - Connect the equipment into an outlet on a circuit different from that to which the receiver is connected.
 - Consult the dealer or an experienced radio/TV technician for help.
- Information to user
 - Alternation or modifications carried out without appropriate authorization may invalidate the user's right to operate the equipment.

INFORMATION

- This XM[®] tuner supports "Audio Services" (Music and Talk) of only XM[®] Satellite Radio and "Text Information*" linked to the respective "Audio Services".

*: Text Information includes, Station Name, (Artist) Name, (Song) Title and Category Name.

6. CD PLAYER OPERATION

The CD player can play audio CDs, CD text and MP3/WMA discs.

(a) Audio CD, CD text (see page 35)

(b) MP3/WMA disc (see page 37)

For appropriate discs for this player, see "AUDIO SYSTEM OPERATING HINTS" on page 59.

INSERTING OR EJECTING A DISC

INSERTING A DISC

- 1 Insert a disc with the label side up.

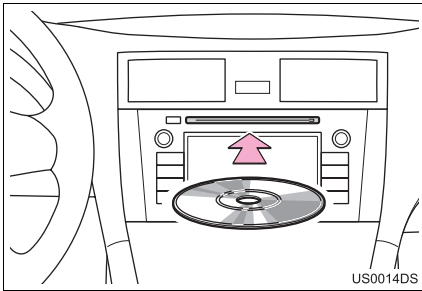

- When a disc is correctly inserted into the slot, the CD player will automatically start playing from the first track or the first file of the first folder on a disc.

INFORMATION

- If the label is facing down, "Check DISC" will appear on the screen.
- The player is intended for use with 12 cm (4.7 in.) discs only. To play 8 cm (3 in.) discs, use an adaptor.

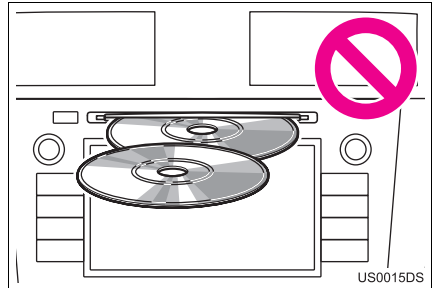

NOTICE

- Do not stack up two discs for insertion, or it will cause damage to the CD player. Insert only one disc into the slot at a time.
- Never try to disassemble or oil any part of the CD player. Do not insert anything other than a disc into the slot.

EJECTING A DISC

- 1 Press the  button.

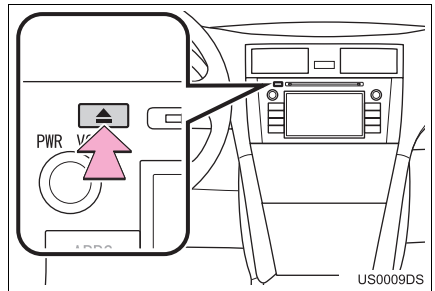

- The disc will be ejected.

SWITCHING TO CD MODE

- 1 Press the “AUDIO” button.

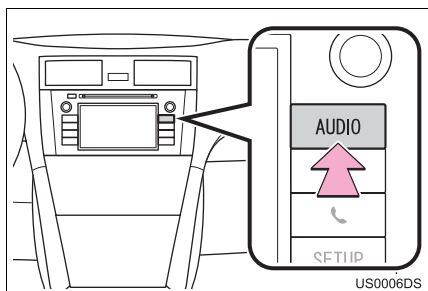



- The audio system turns on in the last mode used.

- 2 Touch “Source” or press “AUDIO” button to display the audio source selection screen.



- 3 Touch “CD” on the screen.



- If a desired source is not displayed on the screen, touch  or  to scroll to it.

INFORMATION

- If no disc is in the slot, “CD” cannot be selected. Insert a disc into the slot.

PLAYING AN AUDIO CD

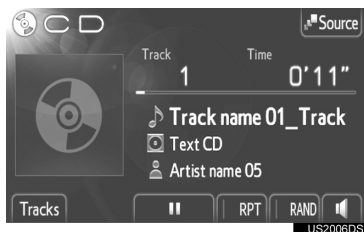

- If a CD-TEXT disc is inserted, the title of the track and disc currently being played will be displayed.

: Touch to pause the track.

: Touch to resume playing the track.

Fast forward and Reverse: Press and hold the “^” or “v” of “SEEK/TRACK” button to fast forward or reverse. When you release the button, the player will start playing from that position.

INFORMATION

- The progress bar indicator does not always correspond to the actual elapsed playback position.

SELECTING A DESIRED TRACK

Select a desired track using one of the following methods.

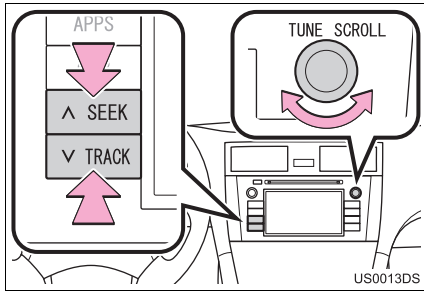

“SEEK/TRACK” button: Press the “^” or “v” of “SEEK/TRACK” button to select a desired track.

“TUNE/SCROLL” knob: Turn this knob to select a desired track. Also, the knob can be used for selection from the list display.

Track list: A desired track can be selected from a list.

- Touch **“Tracks”** on the screen. The list will be displayed.



- Touch a desired track. The player will start playing the selected track from the beginning.
- Touch or to scroll the list.
- If appears to the right of titles, the complete titles are too long for the display. Touch this screen button to scroll to titles.

PLAYING REPEAT AND RANDOM ORDER

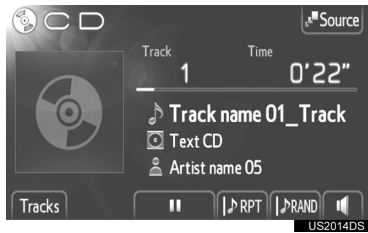

RPT (Repeat mode): Use it to automatically repeat the track you are currently listening to.

- The repeat mode changes as follows each time the screen button is touched.

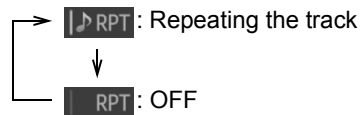

RAND (Random mode): Use it for automatic random selection of the track.

- The random mode changes as follows each time the screen button is touched.

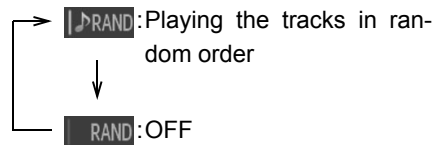

PLAYING A MP3/WMA DISC



- The title of the file and folder currently being played will be displayed.

⏸: Touch to pause the file.

▶: Touch to resume playing the file.

Fast forward and Reverse: Press and hold the “^” or “v” of “SEEK/TRACK” button to fast forward or reverse. When you release the button, the player will start playing from that position.

INFORMATION

- The progress bar indicator does not always correspond to the actual elapsed playback position.

SELECTING A DESIRED FILE

Select a desired file using one of the following methods.

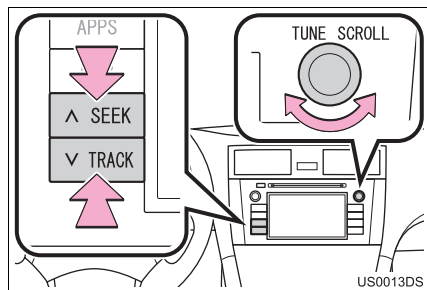

“SEEK/TRACK” button: Press the “^” or “v” of “SEEK/TRACK” button to select a desired file.

“TUNE/SCROLL” knob: Turn this knob to select a desired file. Also, the knob can be used for selection from the list display.

File list: A desired file can be selected from a list.

- Touch “Files” on the screen. The list will be displayed.

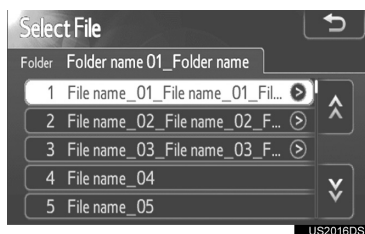

- Touch a desired file. The player will start playing the selected file from the beginning.
- Touch **⬆** or **⬇** to scroll the list.
- If **➤** appears to the right of titles, the complete titles are too long for the display. Touch this screen button to scroll to titles.

SELECTING A DESIRED FOLDER

- 1 Touch **"Folders"** on the screen. The folder list will be displayed.



- 2 Touch a desired folder from the list. The file list for the folder will be displayed.



- When a desired file is touched, the player will start playing the file.
- Touch or to scroll the list.
- If appears to the right of titles, the complete titles are too long for the display. Touch this screen button to scroll to titles.

PLAYING REPEAT AND RANDOM ORDER



RPT (Repeat mode): Use it to automatically repeat the file or folder you are currently listening to.

- The repeat mode changes as follows each time the screen button is touched.

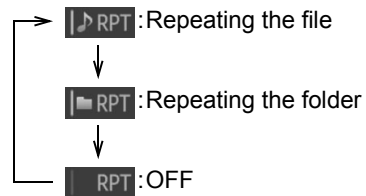

RAND (Random mode): Use it for automatic random selection of the file.

- The random mode changes as follows each time the screen button is touched.

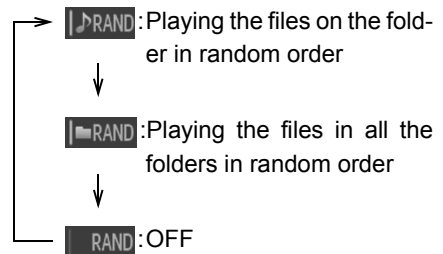

7. iPod OPERATION

Connecting an iPod with the USB port enables users to enjoy music via the vehicle speakers.

CAUTION

- Do not connect an iPod or operate the device controls while driving.

NOTICE

- Do not leave the iPod in the car. In particular, high temperatures inside the vehicle may damage the iPod.
- Do not push down on or apply unnecessary pressure to the iPod while it is connected as this may damage the iPod or its terminal.
- Do not insert foreign objects into the USB port as this may damage the iPod or its terminal.

INFORMATION

- This system has a charging function for iPods.
- When the battery level of an iPod is very low, the iPod may not operate. If so, charge the iPod before use.
- Depending on the iPod that is connected to the system, certain functions may not be available. If a function is unavailable due to a malfunction, disconnecting the iPod and reconnecting it may resolve the problem.

CONNECTING AN iPod

- Open the cover of the USB/AUX port and connect an iPod.

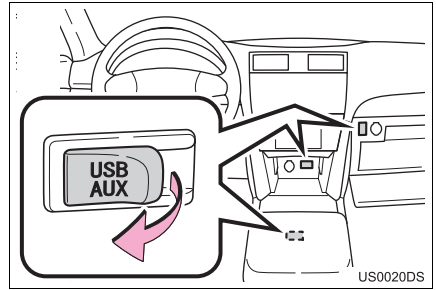

- The USB/AUX port is located on the instrument panel, or in the console box or glove box etc. The location and design are different depending on the vehicle. For details, see the Pictorial index of the vehicle "Owner's Manual".
- Turn on the power of the iPod if it is not turned on.

SWITCHING TO iPod MODE

- Press the "AUDIO" button.

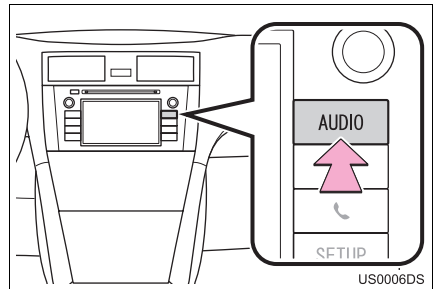



- The audio system turns on in the last mode used.

- 2** Touch **“Source”** or press **“AUDIO”** button to display the audio source selection screen.



- 3** Touch **“iPod”** on the screen.



- If a desired source is not displayed on the screen, touch  or  to scroll to it.

INFORMATION

- If no iPod is connected, the **“iPod”** cannot be selected. Connect the iPod to the USB port.

Fast forward and Reverse: Press and hold the “^” or “v” of **“SEEK/TRACK”** button to fast forward or reverse. When you release the button, the player will start playing from that position.

INFORMATION

- The progress bar indicator does not always correspond to the actual elapsed playback position.

iPod COVER ART

Depending on the iPod and songs in the iPod, iPod cover art may be displayed.

- This function can be changed to “On” or “Off”. See **“GENERAL SETTINGS”** on page 93.

INFORMATION

- It may take time to display iPod cover art, and the iPod may not be operated while the cover art display is in process.
- Only the iPod cover art that is saved in a JPEG format can be displayed.

PLAYING AN iPod

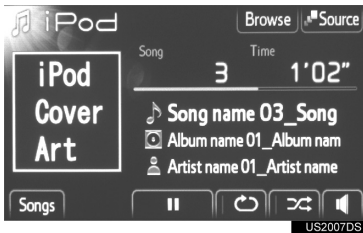

- The title of the album and song will be displayed you are currently listening to.

 : Touch to pause the song.

 : Touch to resume playing the song.

SELECTING A DESIRED SONG

Select a desired song using one of the following methods.

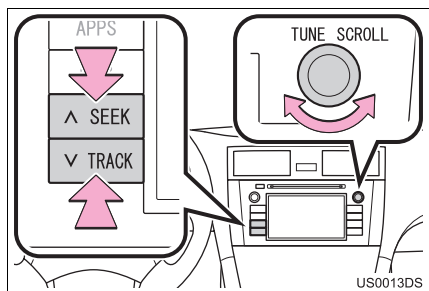





“SEEK/TRACK” button: Press the “^” or “v” of “SEEK/TRACK” button to select a desired song.

“TUNE/SCROLL” knob: Turn this control knob to select a desired song. Also, the knob can be used for selection from the list display.

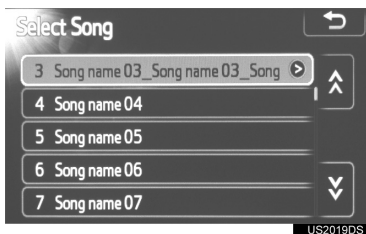
Song list: A desired song can be selected from a list.

- Touch **“Songs”** on the screen. The list will be displayed.



- Touch a desired song. The player will start playing the selected song from the beginning.
- Touch  or  to scroll the list.
- If  appears to the right of titles, the complete titles are too long for the display. Touch this screen button to scroll to titles.



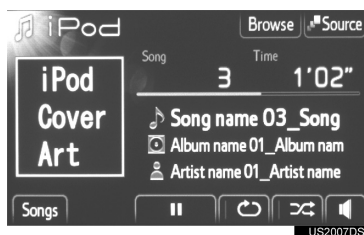

SELECTING A PLAY MODE

- 1 Touch **“Browse”** on the screen.

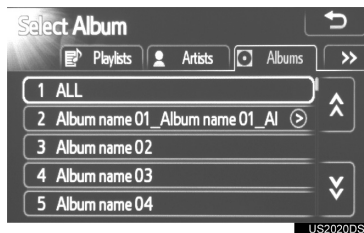



- 2 Touch a desired play mode tab button, such as playlists, artists, albums, songs, podcasts or audio book. And then select the song on each play mode.

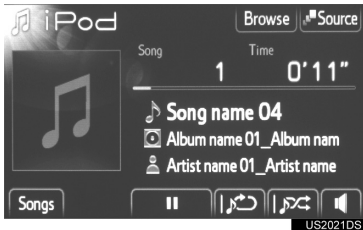

- To scroll the tabs, touch  or .
- Touch  or  to scroll the list.
- If  appears to the right of titles, the complete titles are too long for the display. Touch this screen button to scroll to titles.

PLAYING REPEAT AND SHUFFLE



 **(Repeat mode)**: Use it to automatically repeat the song you are currently listening to.

- The repeat mode changes as follows each time the screen button is touched.

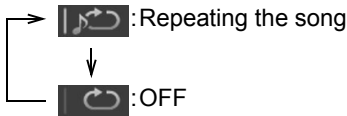

 **(Shuffle mode)**: Use it for automatic shuffling of the songs or albums in an iPod.

- The shuffle mode changes as follows each time the screen button is touched.

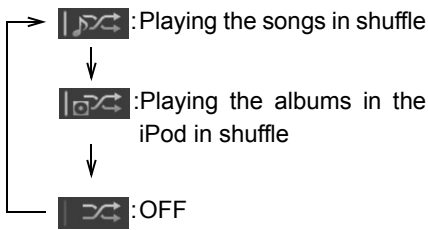

INFORMATION

- When a large number of songs are stored in an iPod, shuffle selection may take time.

8. USB MEMORY OPERATION

Connecting a USB memory with the USB port enables users to enjoy music via the vehicle speakers.

CAUTION

- Do not connect a USB memory or operate the device controls while driving.

NOTICE

- Do not leave the USB memory in the car. In particular, high temperatures inside the vehicle may damage the USB memory.
- Do not push down on or apply unnecessary pressure to the USB memory while it is connected as this may damage the USB memory or its terminal.
- Do not insert foreign objects into the USB port as this may damage the USB memory or its terminal.

INFORMATION

- When USB memory is connected and the audio source is changed to USB mode, the USB memory resumes playback from the position that was last played. However, if files have been moved or deleted from the USB memory, the resume play will not operate.

CONNECTING A USB MEMORY

- Open the cover of the USB/AUX port and connect a USB memory.

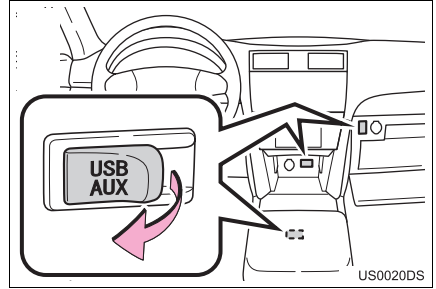

- The USB/AUX port is located on the instrument panel, or in the console box or glove box etc. The location and design are different depending on the vehicle. For details, see the Pictorial index of the vehicle "Owner's Manual".
- Turn on the power of the USB memory if it is not turned on.

SWITCHING TO USB MODE

- Press the "AUDIO" button.

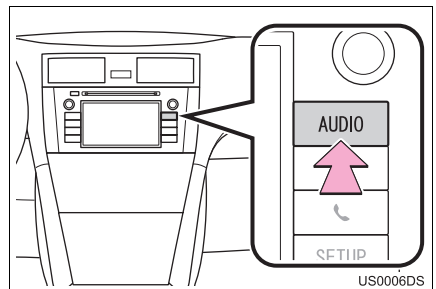



- The audio system turns on in the last mode used.

- 2** Touch **“Source”** or press **“AUDIO”** button to display the audio source selection screen.



- 3** Touch **“USB”** on the screen.



- If a desired source is not displayed on the screen, touch  or  to scroll to it.

INFORMATION

- If no USB memory is connected, the **“USB”** cannot be selected. Connect the USB memory to the USB port.

PLAYING A USB MEMORY



- The title of the file and folder currently being played will be displayed.

 : Touch to pause the file.

 : Touch to resume playing the file.

Fast forward and Reverse: Press and hold the **“^”** or **“v”** of **“SEEK/TRACK”** button to fast forward or reverse. When you release the button, the player will start playing from that position.

INFORMATION

- The progress bar indicator does not always correspond to the actual elapsed playback position.

SELECTING A DESIRED FILE

Select a desired file using one of the following methods.

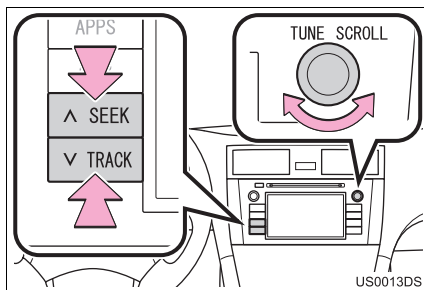

“SEEK/TRACK” button: Press the **“^”** or **“v”** of **“SEEK/TRACK”** button to select a desired file.

“TUNE/SCROLL” knob: Turn this control knob to select a desired file. Also, the knob can be used for selection from the list display.

File list: A desired file can be selected from a list.

- Touch **“Files”** on the screen. The list will be displayed.

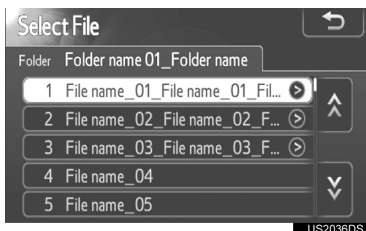

- Touch a desired file. The player will start playing the selected file from the beginning.
- Touch or to scroll the list.
- If appears to the right of titles, the complete titles are too long for the display. Touch this screen button to scroll to titles.

SELECTING A DESIRED FOLDER

- 1 Touch **“Folders”** on the screen. The folder list will be displayed.



- 2 Touch a desired folder from the list. The file list for the folder will be displayed.

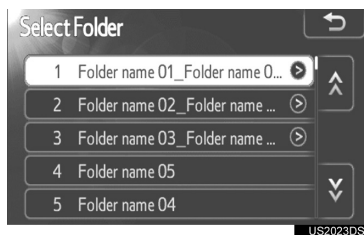

- When a desired file is touched, the player will start playing the file.
- Touch or to scroll the list.
- If appears to the right of titles, the complete titles are too long for the display. Touch this screen button to scroll to titles.

PLAYING REPEAT AND RANDOM ORDER

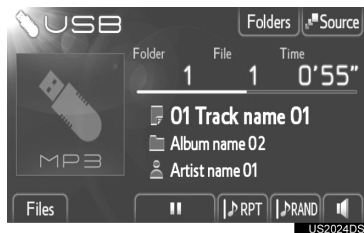

RPT (Repeat mode): Use it to automatically repeat the file or folder you are currently listening to.

- The repeat mode changes as follows each time the screen button is touched.

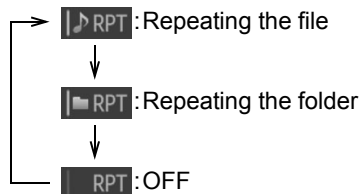

RAND (**Random mode**): Use it for automatic random selection of the file.

- The random mode changes as follows each time the screen button is touched.

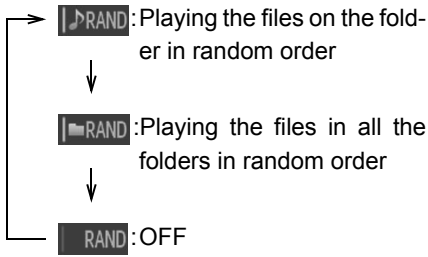

9. AUX DEVICE OPERATION

Connecting a portable audio device with the AUX port enables users to enjoy music via the vehicle speakers.

CAUTION

- Do not connect a portable audio device or operate the device controls while driving.

NOTICE

- Do not leave the portable audio device in the car. In particular, high temperatures inside the vehicle may damage the device.
- Do not push down on or apply unnecessary pressure to the portable audio device while it is connected as this may damage the device or its terminal.
- Do not insert foreign objects into the AUX port as this may damage the portable audio device or its terminal.

CONNECTING A PORTABLE AUDIO DEVICE

- 1 Open the cover of the USB/AUX port and connect a portable audio device.

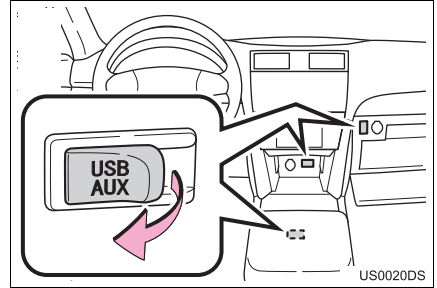

- The USB/AUX port is located on the instrument panel, or in the console box or glove box etc. The location and design are different depending on the vehicle. For details, see the Pictorial index of the vehicle "Owner's Manual".

SWITCHING TO AUX MODE

1 Press the **"AUDIO"** button.

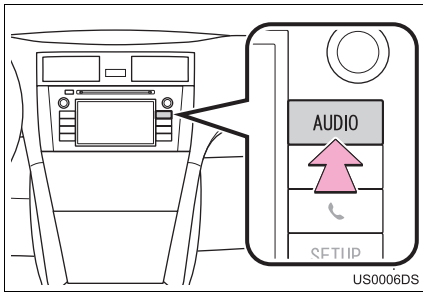

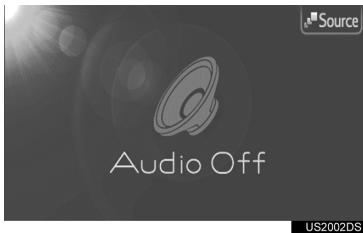

- The audio system turns on in the last mode used.

2 Touch **"Source"** or press **"AUDIO"** button to display the audio source selection screen.



3 Touch **"AUX"** on the screen.



- If a desired source is not displayed on the screen, touch  or  to scroll to it.

INFORMATION

- If no portable audio device is connected, **"AUX"** cannot be selected. Connect the portable audio device to the AUX port.

PLAYING A PORTABLE AUDIO DEVICE



- Only the volume can be adjusted using the audio system controls. The remaining controls need to be operated on the portable audio device itself.

10. Bluetooth® AUDIO OPERATION

The Bluetooth® audio system enables users to enjoy music played on a portable player from the vehicle speaker via wireless communication.

This audio system supports Bluetooth®, a wireless data system capable of playing portable audio music without cables. If your portable player does not support Bluetooth®, the Bluetooth® audio system will not function.



CAUTION

- Do not operate the player's controls or connect to the Bluetooth® audio system while driving.



NOTICE

- Do not leave your portable audio player in the car. In particular, high temperatures inside the vehicle may damage the portable audio player.

INFORMATION

- In the following conditions, the system may not function.
 - The portable audio player is turned off.
 - The portable audio player is not connected.
 - The portable audio player has a low battery.
- Depending on the portable audio player that is connected to the system, certain functions may not be available.
- It may take time, the phone connection is carried out during Bluetooth® audio play.



Bluetooth is a registered trademark of Bluetooth SIG, Inc.

INFORMATION

- Portable audio players must correspond to the following specifications in order to be connected to the Bluetooth® audio system. However, please note that some functions may be limited depending on the type of portable audio player.
 - Bluetooth® Specification
Ver.1.1 or higher
(Recommended: Ver.2.1+EDR or higher)
 - Profile
A2DP (Advanced Audio Distribution Profile)
Ver.1.0 or higher
(Recommended: Ver.1.2 or higher)
This is a profile to transmit stereo audio or high quality sounds to the headphone.
AVRCP (Audio/Video Remote Control Profile)
Ver.1.0 or higher
(Recommended: Ver.1.4 or higher)
This is a profile to remote control the A/V equipments.
- Refer to <http://www.toyota.com/Bluetooth/> to find approved Bluetooth® devices for this system.

CAUTION

- **FCC WARNING:** Changes or modifications not expressly approved by the party responsible for compliance could void the user's authority to operate the equipment.
- **CAUTION: Radio Frequency Radiation Exposure**
This equipment complies with FCC radiation exposure limits set forth for uncontrolled equipment and meets the FCC radio frequency (RF) Exposure Guidelines in Supplement C to OET65 and RSS-102 of the IC radio frequency (RF) Exposure rules. This equipment has very low levels of RF energy that it deemed to comply without maximum permissive exposure evaluation (MPE). But it is desirable that it should be installed and operated with at least 20 cm and more between the radiator and person's body (excluding extremities: hands, wrists, feet and ankles).
- **Co-location:** This transmitter must not be co-located or operated in conjunction with any other antenna or transmitter.

SWITCHING TO Bluetooth® AUDIO MODE

1 Press the “**AUDIO**” button.

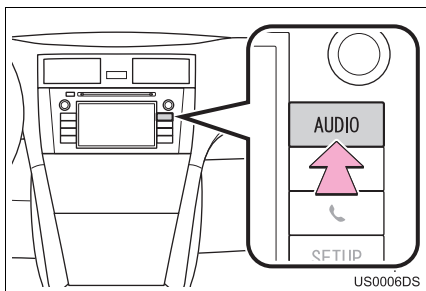



- The audio system turns on in the last mode used.

2 Touch “**Source**” or press “**AUDIO**” button to display the audio source selection screen.



3 Touch “**BT**” on the screen.



- If a desired source is not displayed on the screen, touch  or  to scroll to it.

CONNECTING A Bluetooth® AUDIO PLAYER

To use the Bluetooth® audio system, you need to register your portable audio player into the system. Once you have registered it, you can enjoy your music on the vehicle's audio system.

WHEN A Bluetooth® DEVICE IS NOT REGISTERED

If you have not yet registered any Bluetooth® device, you must first register it according to the following procedure.

- 1 Touch “**Connect**” on the screen.

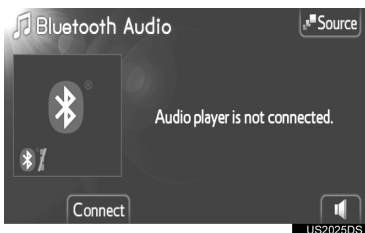

- 2 Touch “**Yes**” to connect your portable player.



- 3 When this screen is displayed, perform a device discovery from your portable audio player.



- 4 Input the passcode displayed on the screen into your portable audio player.

- A passcode is not required for SSP (Secure Simple Pairing) compatible Bluetooth® phones. Depending on the type of Bluetooth® phone being connected, a message confirming registration may be displayed on the Bluetooth® phone's screen. Respond and operate the Bluetooth® phone according to the confirmation message.
- If you want to cancel it, touch “**Cancel**”.

- 5 When the connection is completed, this screen is displayed.



- Once you have registered it, the system automatically connects to your portable audio player device every time you start your vehicle.

- The portable audio player information is registered when the Bluetooth® audio system is connected. When you release possession of your vehicle, remove your portable audio player. (See “REMOVING A Bluetooth® DEVICE” on page 99.)

INFORMATION

- For details on device discovery for your portable audio player, refer to the portable audio player's user's guide.

WHEN A Bluetooth® DEVICE IS REGISTERED

If you have registered some Bluetooth® devices, you can change the device connected and add a new device.

- 1 Touch “**Connect**” on the screen.

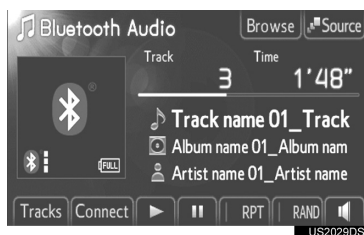

- 2 Touch the portable audio device name to connect.

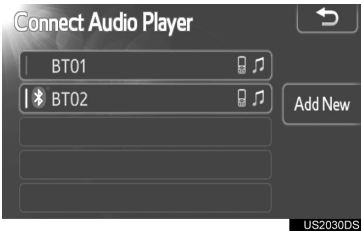

- If you want to add a new device, touch “Add New”. You can register up to 5 devices.

Bluetooth® AUDIO SETTINGS

You can change the Bluetooth® settings. See “Bluetooth® SETTINGS” on page 98.

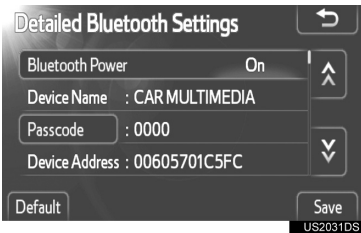

“**Bluetooth* Power**”: When “Bluetooth* Power” is “On”, the Bluetooth® device is automatically connected every time you start your vehicle.

- However, depending on the type of portable audio players or the selected connection method, the device may not be automatically connected.

- This function can be changed to “On” or “Off”. See “DETAILED Bluetooth® SETTINGS” on page 102.

*: Bluetooth is a registered trademark of Bluetooth SIG, Inc.



“**Connection Method**” “**From Vehicle**”: Connect the audio system to the portable audio player.

- However, depending on the type of portable audio player, the device may not be automatically connected.

“**Connection Method**” “**From Audio Player**”: Connect the portable audio player to the audio system.

- This function can be changed to “From Vehicle” or “From Audio Player”. See “DISPLAYING DEVICE DETAILS” on page 100.

PLAYING A Bluetooth® AUDIO PLAYER

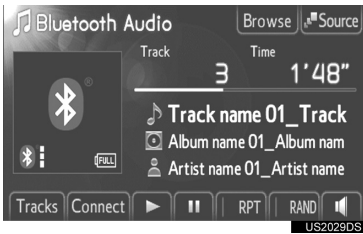

- The title of the track and album currently being played will be displayed.

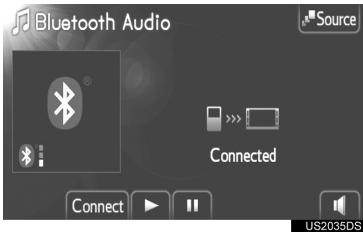

- Some titles and controls may not be displayed depending on the type of Bluetooth® portable audio player.

: Touch to pause the track.

: Touch to resume playing track.

Fast forward and Reverse: Press and hold the “^” or “v” of “SEEK/TRACK” button to fast forward or reverse. When you release the button, the player will start playing from that position.

INFORMATION

- The progress bar indicator does not always correspond to the actual elapsed playback position.
- Depending on the portable audio player that is connected to the system, certain functions may not be available.

STATUS DISPLAY

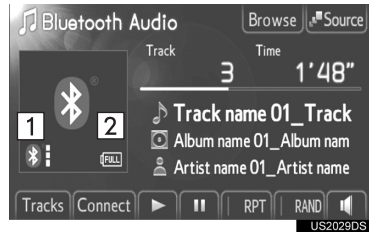

- 1 Indicates the condition of the Bluetooth® connection.



 No connection ←————→ Good

INFORMATION

- An antenna for the Bluetooth® connection is built into in the display. The condition of the Bluetooth® connection may not be good and the system may not function when you use the portable audio player in the following conditions.
 - Your portable audio player is hidden from display (behind the seat or in the glove box and console box).
 - Your portable audio player touches or is covered with metal materials.

2 Indicates the amount of battery charge left.



INFORMATION

- Depending on the type of portable audio players, remaining battery charge is not displayed.
- The amount left does not always correspond to that of the portable audio players.
- This system does not have a charging function.

SELECTING A DESIRED TRACK

Select a desired track using one of the following methods.

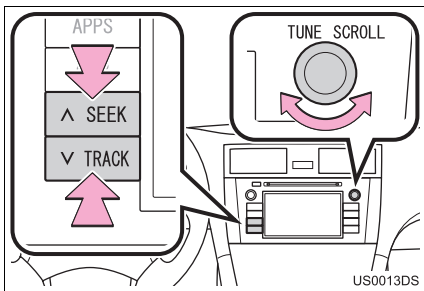

“SEEK/TRACK” button: Press the “^” or “v” of “SEEK/TRACK” button to select a desired track.

“TUNE/SCROLL” knob: Turn this knob to select a desired track. Also, the knob can be used for selection from the list display.

Track list: A desired track can be selected from a list.

- Touch “Tracks” on the screen. The list will be displayed.



- Touch a desired track. The player will start playing the selected track from the beginning.
- Touch or to scroll the list.
- If appears to the right of titles, the complete titles are too long for the display. Touch this screen button to scroll to titles.

SELECTING A DESIRED ALBUM

- 1 Touch “Browse” on the screen. The album list will be displayed.

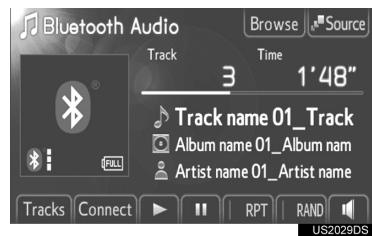

- 2 Touch a desired album from the list. The track list for the album will be displayed.

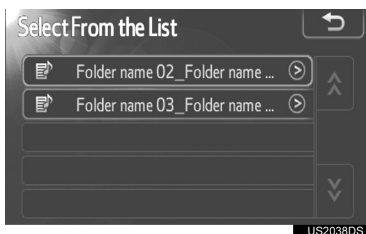

- When a desired track is touched, the player will start playing the track.
- Touch or to scroll the list.
- If appears to the right of titles, the complete titles are too long for the display. Touch this screen button to scroll to titles.

PLAYING REPEAT AND RANDOM ORDER

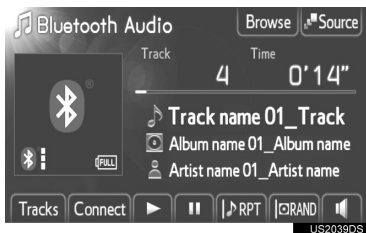

RPT (Repeat mode): Use it to automatically repeat the track or album you are currently listening to.

- The repeat mode changes as follows each time the screen button is touched.

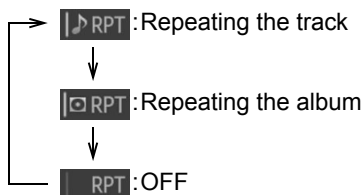

11. STEERING SWITCHES

Some parts of the audio system can be adjusted with the switches on the steering wheel.

STEERING SWITCHES (WITH TWO DIRECTION STEERING SWITCH)

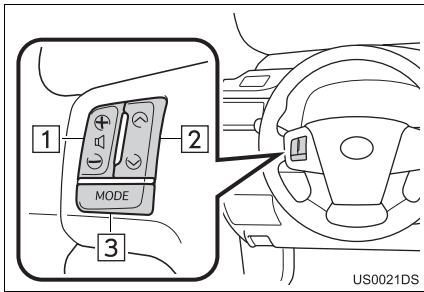

- The design and switch position may differ depending on the vehicle. For details, see the Pictorial index of the vehicle "Owner's Manual".
- Details of the specific switches, controls, and features are described below.

No.	Switch
1	Volume control switch
2	"Λ" "∨" switch
3	"MODE" switch

1 Volume control switch

- Press the "+" side to increase the volume. The volume continues to increase while the switch is being pressed.
- Press the "-" side to decrease the volume. The volume continues to decrease while the switch is being pressed.

2 "Λ" "∨" switch

▶ Radio

To select a preset station: Press the "Λ" or "∨" switch.

To seek a radio station: Press and hold the "Λ" or "∨" switch until you hear a beep. If you press either the "Λ" or "∨" switch in seek mode, the seek mode will be cancelled.

▶ CD player

To select a desired track or file: Press the "Λ" or "∨" switch.

To select a desired folder (MP3/WMA): Press and hold the "Λ" or "∨" switch until you hear a beep.

▶ iPod

To select a desired song: Press the "Λ" or "∨" switch.

▶ USB memory

To select a desired file: Press the "Λ" or "∨" switch.

To select a desired folder: Press and hold the "Λ" or "∨" switch until you hear a beep.

▶ Bluetooth® audio player

To select a desired track: Press the "Λ" or "∨" switch.

To select a desired album: Press and hold the "Λ" or "∨" switch until you hear a beep.

3 "MODE" switch

- Press the "MODE" switch to select an audio mode. Each press changes the mode sequentially if the desired mode is ready to use.
- To turn the audio system on, press the "MODE" switch.
- Press and hold the "MODE" switch until you hear a beep and the music will pause or be muted. By the same operation, it is released.

STEERING SWITCHES (WITH FOUR DIRECTION STEERING SWITCH)

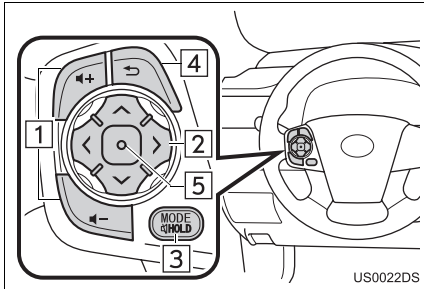

- The design and switch position may differ depending on the vehicle. For details, see the Pictorial index of the vehicle *“Owner’s Manual”*.
- Details of the specific switches, controls, and features are described below.

No.	Switch
1	Volume control switch
2	“^ v > <” switch
3	“MODE” switch
4	Back switch
5	Enter switch

1 Volume control switch

- Press the “+” side to increase the volume. The volume continues to increase while the switch is being pressed.
- Press the “-” side to decrease the volume. The volume continues to decrease while the switch is being pressed.

2 “^ v > <” switch

► Radio

To select a preset station: Press the “^” or “v” side of the switch. Repeat this to select the next preset station.

To seek a station: Press and hold the “^” or “v” side of the switch until a beep is heard. Repeat this to find the next station. If either side of the switch is pressed during seek mode, seeking will be canceled.

To change the preset page: The radio’s preset page can be changed by pressing the “>” or “<” side of the switch.

► CD player

To select a desired track or file: Press the “^” or “v” side of the switch until the desired track or file to play is selected. To return to the beginning of the current track or file, press the “v” side of the switch once quickly.

To select a desired folder (MP3/WMA): Press the “>” or “<” switch to change to the next or the previous folder.

► Bluetooth® audio player

To select a desired track: Press the “^” or “v” side of the switch until the desired track is selected. To return to the beginning of the current track, press the “v” side of the switch once quickly.

To select a desired album: Press the “>” or “<” switch to change to the next or the previous album.

► USB memory/iPod

To select a desired file or song: Press the “^” or “v” switch until the desired file or song is selected. To return to the beginning of the current file or song, press the “v” switch once quickly.

To select a desired play mode tab (iPod): Press “<” or “>” to select the desired play mode tab. If there are no tabs on the screen, this function is not available.

To select a desired folder (USB memory): Press the “>” or “<” switch to change to the next or the previous folder.

3 “MODE” switch

- Press the “**MODE**” switch to select an audio mode. Each press changes the mode sequentially if the desired mode is ready to use.
- To turn the audio system on, press the “**MODE**” switch.
- Press and hold the “**MODE**” switch until you hear a beep and the music will pause or be muted. By the same operation, it is released.

4 Back switch

- Press the back switch to return to the previous screen.

5 Enter switch

- When in radio mode, pressing the enter switch returns to the preset screen.
- When in media mode, pressing the enter switch returns to the list screen.

12. AUDIO SYSTEM OPERATING HINTS

**NOTICE**

- To avoid damaging the audio system:
 - Be careful not to spill beverages over the audio system.
 - Do not put anything other than on appropriate discs into the CD player slot.

INFORMATION

- The use of a cellular phone inside or near the vehicle may cause a noise from the speakers of the audio system which you are listening to. However, this does not indicate a malfunction.

RADIO RECEPTION

Usually, a problem with radio reception does not mean there is a problem with your radio — it is just the normal result of conditions outside the vehicle.

For example, nearby buildings and terrain can interfere with FM reception. Power lines or telephone wires can interfere with AM signals. And of course, radio signals have a limited range, and the farther you are from a station, the weaker its signal will be. In addition, reception conditions change constantly as your vehicle moves.

Here are some common reception problems that probably do not indicate a problem with your radio.

FM

Fading and drifting stations: Generally, the effective range of FM is about 25 miles (40 km). Once outside this range, you may notice fading and drifting, which increase with the distance from the radio transmitter. They are often accompanied by distortion.

Multi-path: FM signals are reflective, making it possible for two signals to reach your antenna at the same time. If this happens, the signals will cancel each other out, causing a momentary flutter or loss of reception.

Static and fluttering: These occur when signals are blocked by buildings, trees, or other large objects. Increasing the bass level may reduce static and fluttering.

Station swapping: If the FM signal you are listening to is interrupted or weakened, and there is another strong station nearby on the FM band, your radio may tune in the second station until the original signal can be picked up again.

AM

Fading: AM broadcasts are reflected by the upper atmosphere — especially at night. These reflected signals can interfere with those received directly from the radio station, causing the radio station to sound alternately strong and weak.

Station interference: When a reflected signal and a signal received directly from a radio station are very nearly the same frequency, they can interfere with each other, making it difficult to hear the broadcast.

Static: AM is easily affected by external sources of electrical noise, such as high tension power lines, lightning, or electrical motors. This results in static.

XM®

- Cargo loaded on the roof luggage carrier, especially metal objects, may adversely affect the reception of XM® Satellite Radio.
- Alternation or modifications carried out without appropriate authorization may invalidate the user's right to operate the equipment.

iPod

ABOUT iPod

- "Made for iPod" and "Made for iPhone" means that an electronic accessory has been designed to connect specifically to iPod, or iPhone, respectively, and has been certified by the developer to meet Apple performance standards.
- Apple is not responsible for the operation of this device or its compliance with safety and regulatory standards.
- iPhone, iPod, iPod classic, iPod nano, iPod shuffle, and iPod touch are trademarks of Apple Inc., registered in the U.S. and other countries.

COMPATIBLE MODELS

Model	Generation	Software Version
iPod	5G	1.3.0
iPod classic	1G	1.1.2
	2G	2.0.1
	2009 (160GB)	2.0.4
iPod nano	1G	1.3.1
	2G	1.1.3
	3G	
	4G	1.0.4
	5G	1.0.2
	6G	1.0.0
iPod touch	1G	iOS 3.1.3
	2G	iOS 3.1.3 iOS 4.2.1
	2009 (8GB)	
	3G	
	4G	iOS 4.2.1
iPhone	iPhone	iOS 3.1.3
	iPhone 3G	iOS 3.1.3 iOS 4.2.1
	iPhone 3GS	
	iPhone 4	iOS 4.2.1

Depending on differences between models or software versions etc., some models listed above might be incompatible with this system.

iPod 4th generation and earlier models are not compatible with this system.

iPad, iPod mini, iPod shuffle and iPod photo are not compatible with this system.

USB MEMORY

- USB memory that can be used for MP3 and WMA playback.
 - USB communication formats: USB 2.0 FS (12 Mbps)
 - File formats: FAT 16/32 (Windows®)
 - Correspondence class: Mass storage class

CARING FOR YOUR CD PLAYER AND DISCS

- Your CD player is intended for use with 12 cm (4.7 in.) discs only. To play 8 cm (3 in.) discs, use an adaptor.
- Extremely high temperatures can keep your CD player from working. On hot days, use air conditioning to cool the vehicle interior before you listen to a disc.
- Bumpy roads or other vibrations may make your CD player skip.
- If moisture gets into your CD player, you may not hear any sound even though your CD player appears to be working. Remove the discs from the CD player and wait until it dries.

CAUTION

- CD player uses an invisible laser beam which could cause hazardous radiation exposure if directed outside the unit. Be sure to operate the CD player correctly.

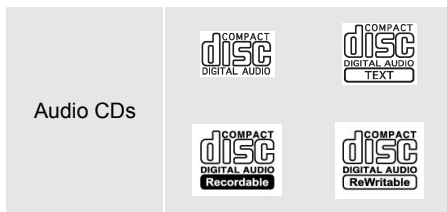

- Use only discs marked as shown above. The following products may not be playable on your CD player.
 - SACDs
 - dts CDs
 - Copy-protected CDs
 - Video CDs
- ▶ Special shaped discs

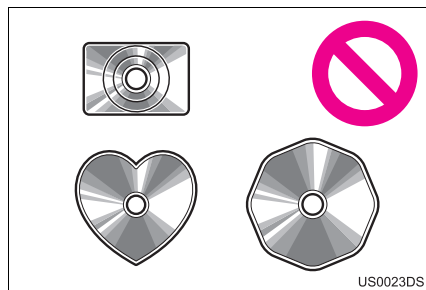

- ▶ Transparent/translucent discs

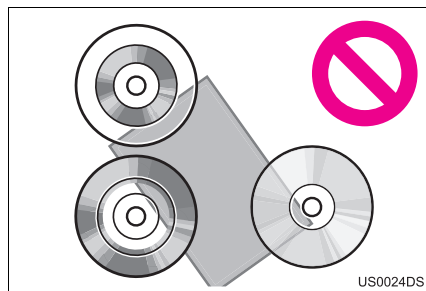

► Low quality discs

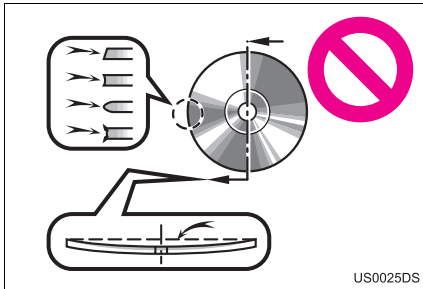

► Labeled discs

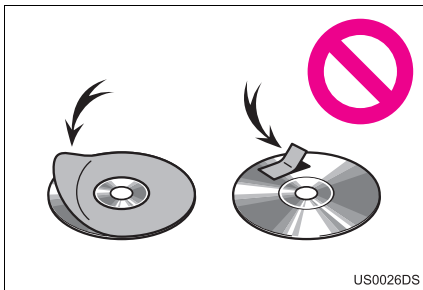

⚠ NOTICE

- Do not use special shaped, transparent/translucent, low quality or labeled discs such as those shown in the illustrations. The use of such discs may damage the player, or it may be impossible to eject the disc.
- This system is not designed for use of Dual Disc. Do not use Dual Disc because it may cause damage to the player.

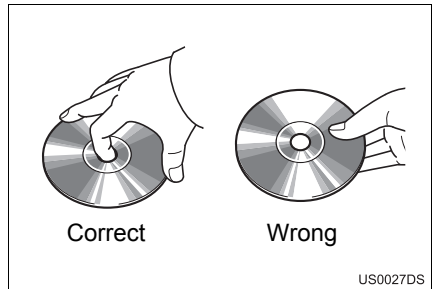

- Handle discs carefully, especially when you are inserting them. Hold them on the edge and do not bend them. Avoid getting fingerprints on them, particularly on the shiny side.
- Dirt, scratches, warping, pin holes, or other disc damage could cause the CD player to skip or to repeat a section of a track. (To see a pin hole, hold the disc up to the light.)
- Remove discs from the CD player when you are not using them. Store them in their plastic cases away from moisture, heat, and direct sunlight.

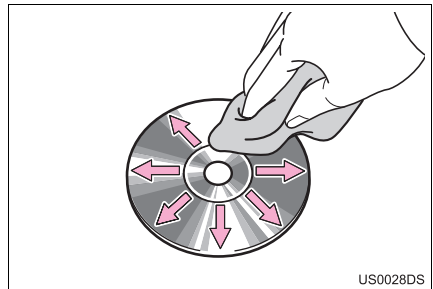

- **To clean a disc:** Wipe it with a soft, lint-free cloth that has been dampened with water. Wipe in a straight line from the centre to the edge of the disc (not in a circle). Do not use a conventional record cleaner or anti-static device.

MP3/WMA FILES

- MP3 (MPEG Audio Layer 3) and WMA (Windows Media Audio) are audio compression standards.
- The MP3/WMA player can play MP3 and WMA files on CD-ROM, CD-R and CD-RW discs.
The unit can play disc recordings compatible with ISO 9660 level 1,2 (Romeo Joliet) and UDF (2.01 or lower) file system.
- When naming an MP3 or WMA file, add the appropriate file extension (.mp3 or .wma).
- The MP3/WMA player plays back files with .mp3 or .wma file extensions as MP3 or WMA files. To prevent noise and playback errors, use the appropriate file extensions.
- The player can play only the first session using multi-session compatible CDs.
- MP3 files are compatible with the ID3 Tag Ver. 1.0, Ver. 1.1, Ver. 2.2, and Ver. 2.3 formats. The unit cannot display disc title, track title and artist name in other formats.
- USB memory: MP3 files are compatible with the ID3 Tag Ver. 1.0, Ver. 1.1, Ver. 2.2, Ver. 2.3 and Ver. 2.4 formats. The unit cannot display track title and artist name in other formats.
- WMA files can contain a WMA tag that is used in the same way as an ID3 tag. WMA tags carry information such as track title, artist name.
- The sound quality of MP3/WMA files generally improves with higher bit rates. In order to achieve a reasonable level of sound quality, files recorded with a bit rate of at least 128 kbps are recommended.

SAMPLING FREQUENCY

MP3 files:

MPEG 1 AUDIO LAYER 3 — 32, 44.1, 48 kHz

MPEG2 AUDIO LAYER3 — 16, 22.05, 24 kHz

WMA files for WMA player:

Ver. 7, 8, 9 CBR — 32, 44.1, 48 kHz

WMA files for USB memory:

Ver. 7, 8, 9 — HIGH PROFILE 32, 44.1, 48 kHz

PLAYABLE BIT RATES

MP3 files for MP3 player:

MPEG1 LAYER3 — 32 to 320 kbps

MPEG2 LSF LAYER3 — 8 to 160 kbps

MP3 files for USB memory:

MPEG 1 AUDIO LAYER 2, 3 — 32 to 320 kbps

MPEG 2 AUDIO LAYER 2, 3 — 8 to 160 kbps

WMA files for WMA player:

Ver. 7, 8 CBR — 48 to 192 kbps

Ver. 9 CBR — 48 to 320 kbps

WMA files for USB memory:

Ver. 7, 8, 9 CBR — 48 to 320 kbps

- M3u playlists are not compatible with the audio player.
- MP3i (MP3 interactive) and MP3PRO formats are not compatible with the audio player.
- The player is compatible with VBR (Variable Bit Rate).
- When playing back files recorded as VBR (Variable Bit Rate) files, the play time will not be correctly displayed if fast-forward or reverse operations are used.
- It is not possible to check folders that do not include MP3/WMA files.

- MP3/WMA files in folders up to 8 levels deep can be played. However, the start of playback may be delayed when using discs containing numerous levels of folders. For this reason, we recommend creating discs with no more than two levels of folders.
- WMA files Ver. 9 depends on “Windows Media® Audio Standard”.

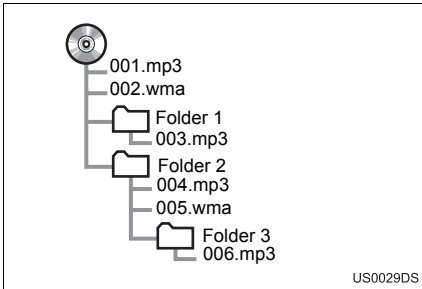

- The play order of the compact disc with the structure shown on the left is as follows:

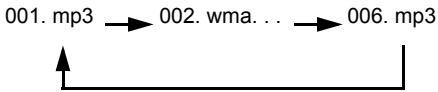

- MP3/WMA player: It is possible to play up to 192 folders or 255 files on one disc.
- USB memory:
 - Maximum number of folder in device: 3000
 - Maximum number of files in one folder: 255
 - Maximum number of files in device: 9999
- The order changes depending on the PC and MP3/WMA encoding software you use.

CD-R AND CD-RW DISCS

- CD-R/CD-RW discs that have not been subject to the “finalizing process” (a process that allows discs to be played on a conventional CD player) cannot be played.
- It may not be possible to play CD-R/CD-RW discs recorded on a music CD recorder or a personal computer because of disc characteristics, scratches or dirt on the disc, or dirt, condensation, etc. on the lens of the unit.
- It may not be possible to play discs recorded on a personal computer depending on the application settings and the environment. Record with the correct format. (For details, contact the appropriate application manufacturers of the applications.)
- CD-R/CD-RW discs may be damaged by direct exposure to sunlight, high temperatures or other storage conditions. The unit may be unable to play some damaged discs.
- If you insert a CD-RW disc into the MP3/WMA player, playback will begin more slowly than with a conventional CD or CD-R disc.
- Recordings on CD-R/CD-RW cannot be played using the DDCD (Double Density CD) system.

TERMS

PACKET WRITE

- This is a general term that describes the process of writing data on-demand to CD-R, etc., in the same way that data is written to floppy or hard discs.

ID3 TAG

- This is a method of embedding track-related information in an MP3 file. This embedded information can include the track title, the artist's name, the album title, the music genre, the year of production, comments and other data. The contents can be freely edited using software with ID3 tag editing functions. Although the tags are restricted to the number of characters, the information can be viewed when the track is played back.

WMA TAG

- WMA files can contain a WMA tag that is used in the same way as an ID3 tag. WMA tags carry information such as track title, artist name.

ISO 9660 FORMAT

- This is the international standard for the formatting of CD-ROM folders and files. For the ISO 9660 format, there are two levels of regulations.
- Level 1: The file name is in 8.3 format (8 character file names, with a 3 character file extension. File names must be composed of one-byte capital letters and numbers. The “_” symbol may also be included.)
- Level 2: The file name can have up to 31 characters (including the separation mark “.” and file extension). Each folder must contain fewer than 8 hierarchies.

m3u

- Playlists created using “WINAMP” software have a playlist file extension (.m3u).



MP3

- MP3 is an audio compression standard determined by a working group (MPEG) of the ISO (International Standard Organization). MP3 compresses audio data to about 1/10 the size of that on conventional discs.

WMA

- WMA (Windows Media Audio) is an audio compression format developed by Microsoft®. It compresses files into a size smaller than that of MP3 files. The decoding formats for WMA files are Ver. 7, 8, and 9.

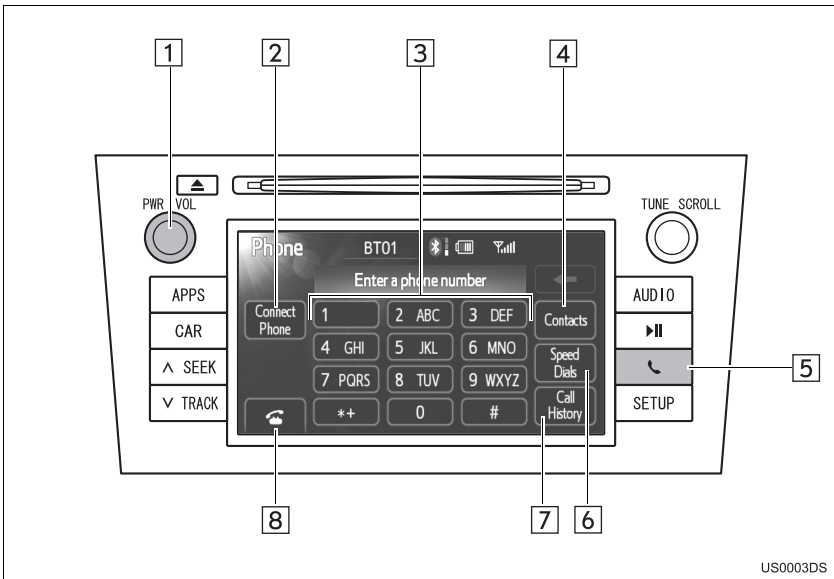

1. QUICK REFERENCE

This screen can be used to make a phone call. To display the “Phone” screen, press the  switch on the steering wheel or the  button.



US0003DS

● The actual design and button position may differ depending on the vehicle. For details, see Section 3 of the vehicle “Owner’s Manual”.

No.	Name	Function	Page
1	“PWR/VOL” knob	Turn this knob to adjust the volume.	82, 83
2	“Connect Phone”	You can connect a Bluetooth® device to the system.	75
3	Number keys	Used for inputting a phone number.	76
4	“Contacts”	Displays “Contacts” screen to make a call using the phonebook.	76
5	 button	Displays “Phone” screen.	74, 76, 82
6	“Speed Dials”	Displays “Speed Dial” screen to make a call using the speed dial.	77
7	“Call History”	Displays “Call History” screen to make a call using the call history.	78
8		Used for making a phone call.	76, 82

2. HANDS-FREE SYSTEM

Bluetooth® hands-free system allows you to make or receive a call without taking your hands off the steering wheel by connecting your cellular phone.

This system supports Bluetooth®. Bluetooth® is a wireless data system by which you can call without your cellular phone being connected with a cable or placed on a cradle.

The operating procedure of the system is explained in this section.

- For registering and setting of the phone, see "PHONE SETTINGS" on page 106.



CAUTION

- Use a cellular phone or connect the Bluetooth® phone only when safe and legal to do so.



NOTICE

- Do not leave your cellular phone in the car. The temperature inside may be high and damage the phone.
- If the Bluetooth® phone is too close to the system, quality of the sound may deteriorate and connecting condition may go down.

INFORMATION

- If your cellular phone does not support Bluetooth®, this system will not function.
- Depending on the cellular phone models, some functions may be restricted.
- In the following conditions, the system may not function.
 - The cellular phone is turned off.
 - The current position is outside the communication area.
 - The cellular phone is not connected.
 - The cellular phone has a low battery.
 - When outgoing is controlled, due to heavy traffic on telephone lines, etc.
 - When the cellular phone itself cannot be used
 - When transferring the phonebook data from the cellular phone
- Even if your cellular phone supports both hands-free and audio Bluetooth® connections, it may not be able to connect to the hands-free connection at the same time.
- When using Bluetooth® audio and hands-free at the same time, the following problems may occur.
 - The Bluetooth® connection may be cut.
 - Noise may be heard on the Bluetooth® audio playback.
- The Bluetooth® phone battery will burn out quickly when it is connected to Bluetooth®.



Bluetooth is a registered trademark of Bluetooth SIG, Inc.

INFORMATION

- This system supports the following service.
- Bluetooth® Specification Ver.1.1 or higher
(Recommended: Ver.2.1+EDR or higher)
- Profile
 - HFP (Hands Free Profile) Ver.1.0 or higher
(Recommended: Ver.1.5 or higher)
This is a profile to allow hands-free phone call using the cellular phone or head sets. It has an outgoing and incoming call function.
 - OPP (Object Push Profile) Ver.1.1 or higher
This is a profile to exchange phone-book data. When the Bluetooth® phone has PBAP and OPP, OPP cannot be used.
 - PBAP (Phone Book Access Profile) Ver.1.0 or higher
This is a profile to transfer phone-book data.
- If your cellular phone does not support HFP, you cannot register the Bluetooth® phone, and take OPP or PBAP service individually.
- Refer to <http://www.toyota.com/Bluetooth/> to find approved Bluetooth® devices for this system.

USING THE PHONE SWITCH

The actual design and button position may differ depending on the vehicle. For details, see the Pictorial index of the vehicle "Owner's Manual".

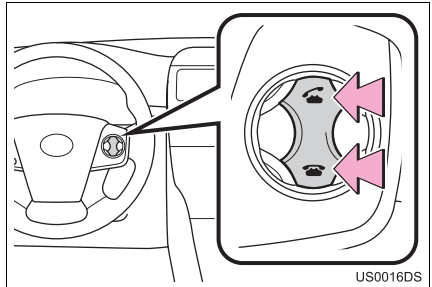

- By pressing the phone switch, you can receive a call or hang up without taking your hands off the steering wheel.

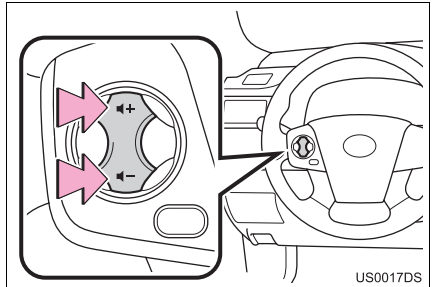

- By pressing the volume switch, you can adjust the volume.

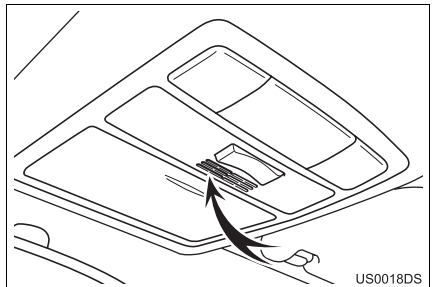

- You can use the microphone when talking on the phone.

INFORMATION

- The other party's voice outputs from the front speaker. When the received calls or received voice outputs, the audio from the audio system will be muted.
- Talk alternately with the other party on the phone. If you talk at the same time, your voices may not reach each other. (It is not a malfunction.)
- Keep the volume of receiving voice down. Otherwise, an echo will be heard and receiving voice can be heard outside of the vehicle. When you talk on the phone, speak clearly towards the microphone.
- In the following situations, your voice may not reach the other party.
 - Driving on an unpaved road. (Due to traffic noise.)
 - Driving at high speed.
 - A window is open.
 - Turning the air-conditioning vents towards the microphone.
 - The sound of the air-conditioning fan is loud.
 - There is an effect from the cellular phone network.

ABOUT THE PHONEBOOK IN THIS SYSTEM

- The following data is stored for every registered phone. When another phone is connecting, you cannot read the registered data.
 - Phonebook data
 - Call history data
 - Speed dial data

INFORMATION

- When you delete the phone, the above-mentioned data is also deleted.

WHEN YOU RELEASE YOUR CAR

A lot of personal data is registered when you use the Hands-free system. When you release your car, initialize your data. (See "DELETE PERSONAL DATA" on page 94.)

- You can initialize the following data in the system.
 - Phonebook data
 - Call history data
 - Speed dial data
 - Bluetooth® phone data
 - Volume setting
 - Details setting

INFORMATION

- If you initialize it, the former state will never come back again. Pay attention when initializing the data.

CAUTION

- **FCC WARNING:** Changes or modifications not expressly approved by the party responsible for compliance could void the user's authority to operate the equipment.
- **CAUTION: Radio Frequency Radiation Exposure**
This equipment complies with FCC radiation exposure limits set forth for uncontrolled equipment and meets the FCC radio frequency (RF) Exposure Guidelines in Supplement C to OET65 and RSS-102 of the IC radio frequency (RF) Exposure rules. This equipment has very low levels of RF energy that it deemed to comply without maximum permissive exposure evaluation (MPE). But it is desirable that it should be installed and operated with at least 20 cm and more between the radiator and person's body (excluding extremities: hands, wrists, feet and ankles).
- **Co-location:** This transmitter must not be co-located or operated in conjunction with any other antenna or transmitter.

PHONE STATUS DISPLAY



1 Indicates the condition of the Bluetooth® connection.



2 Indicates the amount of battery charge left.



- This is not displayed when the Bluetooth® phone is not connected.
- Depending on the type of Bluetooth® phone, remaining battery charge may not be displayed.
- The amount left may not always correspond to that of the Bluetooth® phone. This system does not have a charging function.

3 Indicates the receiving area.

“Rm” is displayed when receiving in Roaming area.

- The receiving area may not be displayed depending on the phone you have.

4 Indicates the level of reception.



- The level of reception does not always correspond with the one of your cellular phone.
- The level of reception may not be displayed depending on the phone you have.
- When you are out of the service area or in a place inaccessible by radio waves, “No Service” is displayed.

INFORMATION

- An antenna for the Bluetooth® connection is built into the display.
- The condition of the Bluetooth® connection may not be good and the system may not function when you use the Bluetooth® phone in the following conditions.
 - Your Bluetooth® phone is hidden from the display (behind the seat or in the glove box or console box).
 - Your Bluetooth® phone touches or is covered with metal materials.
- Leave the Bluetooth® phone in the place where the Bluetooth® sensitivity is good.

3. REGISTER A Bluetooth® PHONE

To use the Bluetooth® hands-free system, you need to register your phone into the system. Once you have registered it, you can make hands-free calls.

If you have not yet registered any Bluetooth® phones, you must first register it according to the following procedure.

● Please see “REGISTERED DEVICES” on page 98 of additional registration when registering.

1 Press the  button or the  switch on the steering wheel.

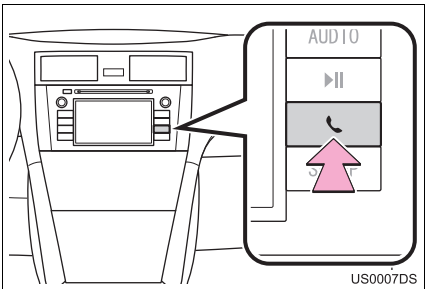

2 Touch “Yes” to register your Bluetooth® phone.



3 When this screen is displayed, perform a device discovery from your Bluetooth phone.

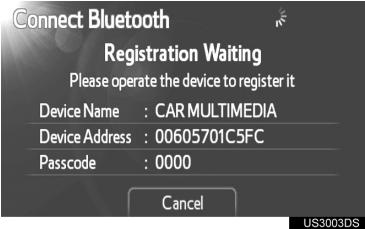

4 Input the passcode displayed on the screen into the phone.

- A passcode is not required for SSP (Secure Simple Pairing) compatible Bluetooth® phones. Depending on the type of Bluetooth® phone being connected, a message confirming registration may be displayed on the Bluetooth® phone’s screen. Respond and operate the Bluetooth® phone according to the confirmation message.
- If you want to cancel it, touch “Cancel”.
- If the Bluetooth® phone to be registered has a Bluetooth® audio function, this can be registered at the same time.

- 5 When the connection is completed, this screen is displayed.



- Once you have registered it, the system automatically connects to your Bluetooth® device every time you start your vehicle. (For automatic connection, see "CHANGING THE Bluetooth® POWER" on page 103.)
- If the Bluetooth® is disconnected on purpose such as you turned your Bluetooth phone off, this does not happen. Reconnect the Bluetooth® phone manually.

INFORMATION

- For details on device discovery for your Bluetooth phone, refer to the Bluetooth phone's user's guide.

SELECTING AND ADDING A Bluetooth® PHONE

If you have registered some Bluetooth® devices, you can change the device connected and add a new device.

- 1 Touch "Connect Phone".

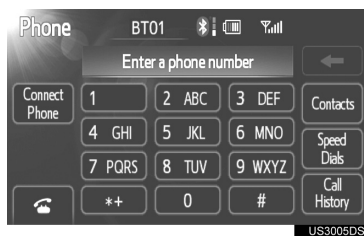

- 2 Touch the Bluetooth® devices name to connect.



- The selection indicator is displayed on left side of the selected device name.
- The Bluetooth® mark is displayed when you connected the device.
- If you want to add a new device, touch "Add New". You can register up to 5 devices.

INFORMATION



- When you connect the phone while Bluetooth® audio is playing, the Bluetooth® audio will stop temporarily. It may take time, the phone connection is carried out during Bluetooth® audio play. The audio may be skipped.

4. CALL ON THE Bluetooth® PHONE



After you register the Bluetooth® phone, you can call by using Bluetooth® hands-free system.

BY DIAL

You can call by inputting the phone number.

- 1 Press the  switch on the steering wheel or the  button to display the “Phone” screen.
- 2 Enter a phone number by touching number keys (0 - 9, *, #, +).





- Each time you touch , an inputted digit is deleted.
 - For the first digit, you can enter “+” by touching “*” for a while.
- 3 Touch  or press the  switch on the steering wheel.

BY PHONEBOOK

You can make a call using the phonebook data which is transferred from your cellular phone.

The system has one phonebook for each phone. You can register up to 1000 contacts in each phonebook.

- 1 Press the  switch on the steering wheel or the  button to display the “Phone” screen.
- 2 Touch “**Contacts**”.





- 3 Touch the desired data from the list.

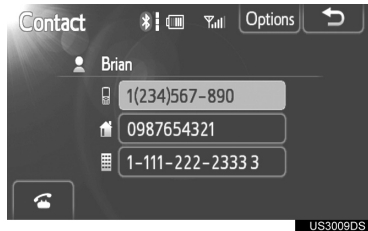

- 4 Touch the desired number from the list.



- 5 Touch  or press the  switch on the steering wheel.

WHEN THE PHONEBOOK IS EMPTY

- 1 Touch **“Contacts”**.



- If your phone does not support either PBAP or OPP service, you cannot transfer contacts.

▶ PBAP compatible models

- 2 Touch **“Yes”** if you want to transfer new contacts from a cellular phone.

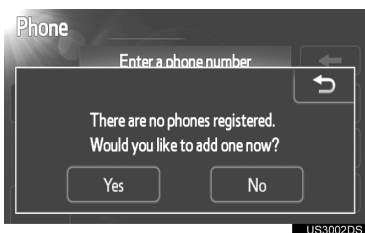

- Touch **“No”** if you want to cancel transferring the contacts.

▶ PBAP incompatible but OPP compatible models

- 2 Touch **“Transfer”** if you want to transfer new contacts from a cellular phone.



- You need to operate your phone to transfer new contacts.

- Touch **“Cancel”** if you want to cancel transferring the contacts.

BY SPEED DIAL

You can call using registered phone numbers which can be selected from a phonebook. (See “SPEED DIALS SETTING” on page 111 for registering the speed dial.)

- 1 Press the switch on the steering wheel or the button to display the “Phone” screen.

- 2 Touch **“Speed Dials”**.



- 3 Touch the desired number to call.

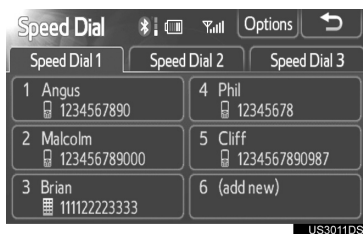

- You can change the page by touching **“Speed Dial 2”** or **“Speed Dial 3”** tab.

BY CALL HISTORY



You can make a call using the call history which has 4 functions below.

All: all the calls (missed, incoming or outgoing)

Missed: calls which you missed

Incoming: calls which you received

Outgoing: calls which you made

1 Press the  switch on the steering wheel or the  button to display the “Phone” screen.

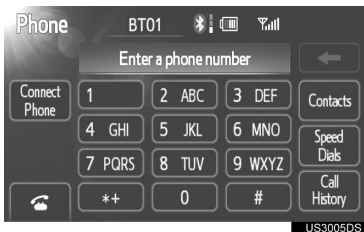

2 Touch “Call History”.



3 Touch the desired data from the list.



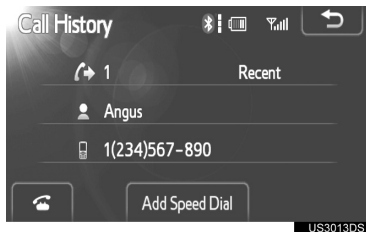

● When the list is switched, touch “All”, “Missed”, “Incoming” or “Outgoing” tab.

4 Touch  or press the  switch on the steering wheel.





You can make a call using the latest call history item.

1 Press the  switch on the steering wheel to display the “Phone” screen.

2 Press the  switch on the steering wheel to display the “Call History” screen.

3 Press the  switch on the steering wheel to select the latest history item.

4 Press the  switch on the steering wheel or touch  to call the latest history item.

● When you call using the phonebook, the name (if registered) is displayed.

● When you call the same number continuously, only the newest number is registered.

● When a phone number registered in the phonebook is received, the name and the number are displayed.

INFORMATION

● Number-withheld calls are also memorized in the system.

● A international phone call may not be made depending on the cellular phone which you have.

BY VOICE RECOGNITION (IF EQUIPPED)

Calls can be made by giving a voice command.

This can be operated while driving.

1 Press the talk switch.

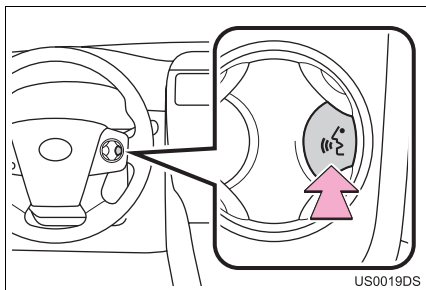

- The actual design and button position may differ depending on the vehicle. For details, see the Pictorial index of the vehicle "Owner's Manual".

2 After a beep sounds, say the command of your choice.

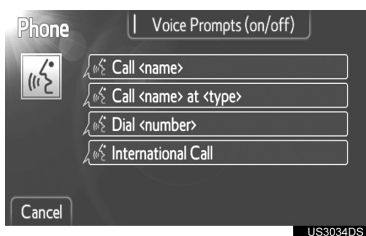

- Voice commands are marked with .

3 Say the command displayed on the screen.

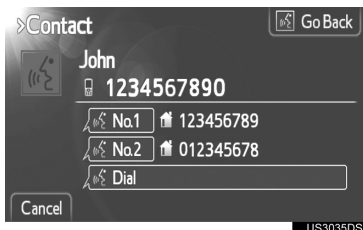

- If a desired outcome is not shown, or if no selections are available, perform one of the following to return to the previous screen:
 - Say "Go back"
 - Touch "Go Back"
- To cancel voice recognition, touch "Cancel", or press and hold the talk switch.

INFORMATION

- Voice guidance for the voice recognition system can be skipped by pressing the talk switch.
- The voice recognition prompt can be set to on or off when "Voice Prompts (on/off)" is touched. This setting can also be changed on the "Guidance Settings" screen. (See page 95.)
- When "Voice Prompts (on/off)" is touched, voice recognition will be temporarily suspended. Press the talk switch again.
- Voice guidance can be canceled by setting voice prompts to off. Use this setting when it is desirable to say a command immediately after pressing the talk switch.

VOICE COMMAND EXAMPLE: CALL NAME

- 1 Press the talk switch.
- 2 Say the name, or the name and type of phone, of a registered contact.

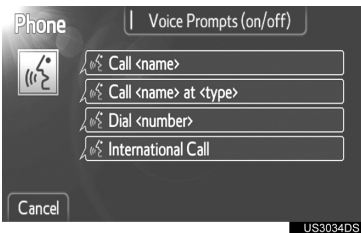

- In the same manner as it is displayed on the screen, "Call <name>" or "Call <name> at <type>," after saying "Call" say the name, or the name and type of phone, of a contact.
For example: "Call", "John Smith" or "Call", "Mary Davis", "at", "Mobile"
- There are 4 types of phones: Home, Mobile, Work and Other.
- Short or abbreviated names in the phonebook may not be recognized. Change names in the phonebook to full names.
- Sometimes a voice recognition result confirmation screen will be displayed. After confirming the result, say "Yes" or "No".
- When the system recognizes multiple names from the phonebook, a name candidate list will be displayed on the screen. If the desired name is not displayed on the top of the screen, say the number of the name from the candidate list (number 1 or number 2) to select a name from the candidate list.
- When a contact has multiple phone numbers registered in the phonebook, a candidate list will be displayed. If the desired phone number is not displayed on the top of the screen, say the number of the desired phone number from the candidate list (number 1 or number 2) to select a phone number from the candidate list.

- 3 Say "Dial" to call the phone number.

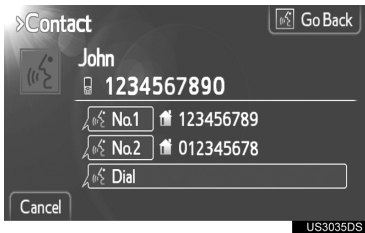

VOICE COMMAND EXAMPLE: DIAL NUMBER

- 1 Press the talk switch.
- 2 Say the phone number.

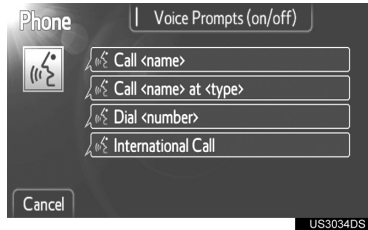

- In the same manner as it is displayed on the screen, "Dial <number>," after saying "Dial" say the phone number.
- Say the phone number one digit at a time. For example, if the phone number is 2345678:
Say "two three four five six seven eight"
Do not say "twenty three forty five sixty seven eight"
- The system can recognize the following types of the phone numbers:
3 digit numbers (911, 411, 611)
7 digit numbers (Local phone numbers)
10 digit numbers (Area code + Local phone number)
11 digit phone numbers (1 + Area code + Local phone number)

- As the system cannot recognize additional numbers, say the complete number without stopping.
 - When the system recognizes multiple phone numbers, a phone number candidate list will be displayed on the screen. If the desired phone number is not displayed on the top of the screen, say the number of the desired phone number from the candidate list (number 1 or number 2) to select a phone number from the candidate list.
- 3** Say **“Dial”** to call the phone number.

INTERNATIONAL CALL

To dial a phone number that is not a 3, 7, 10 or 11 digit number, for example an international number, use “International Call”.

- 1** Press the talk switch.
 - 2** Say **“International call”**.
- Up to 20 digits can be recognized when using the international call function. The number can also be divided into multiple groups and recognized.

Calling without the voice recognition:

After the desired phone number is displayed, a call can also be made by pressing the  switch on the steering wheel.

Canceling the voice recognition: The voice recognition will be canceled when either of the following is performed.

- Press and hold the talk switch.
- Touch **“Cancel”**.

5. RECEIVE ON THE Bluetooth® PHONE

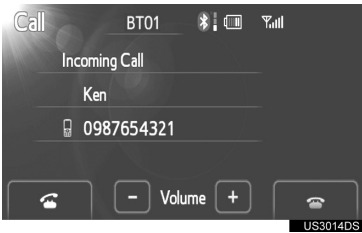

When a call is received, this screen is displayed with a sound.



To answer the phone:

Press the  switch on the steering wheel or touch .

To refuse to receive the call:

Press the  switch on the steering wheel or touch .

To adjust the volume of received call:

Touch “-” or “+”, turn the “PWR/VOL” knob, or use the volume switch on the steering wheel.

INFORMATION



- On the international phone call, the other party’s name may not be displayed correctly depending on the cellular phone which you have.

6. TALK ON THE Bluetooth® PHONE

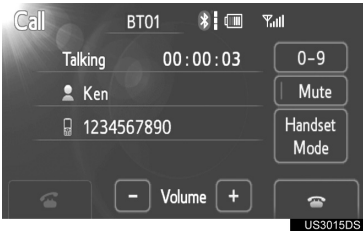
While you are talking on the phone, this screen is displayed. You can do the operation below on the screen.



To adjust the volume of the other party's voice: Touch “-” or “+”, turn the “PWR/VOL” knob, or use the volume switch on the steering wheel.

To hang up the phone: Press the  switch on the steering wheel or touch .

To mute your voice: Touch “Mute”.

To input a Key: Touch “0-9”.

To transfer the call: Touch “Handsfree Mode” or “Handset Mode”.

INFORMATION

- When you change from cellular phone call to Hands-free call, the Hands-free screen will be displayed and you can operate it on the screen.

WHEN YOU TOUCH “0-9”

- 1 Enter a number by touching the number keys.



To hang up the phone: Press the  switch on the steering wheel or touch



- If the continuous tone signal is registered in a phonebook, this screen appears. (If not registered, “Send” and “Exit” are not displayed.)
- Confirm the number displayed on the screen and touch “Send”. The number before marked sign will be sent.
- When you touch “Exit”, this function will be finished and normal tone screen appears.

To hang up the phone: Press the  switch on the steering wheel or touch



INFORMATION

- The continuous tone signal is the marked sign (p or w) and the number following phone number. (ex. 056133w0123p#1*)
- You can do this operation when you want to operate an answering machine or use a telephone service in bank for example. You can register the phone number and the code number in the phonebook.

INTERRUPT CALL

When the call is interrupted by the third party while talking, this screen is displayed.



US3018DS

To answer the phone:

Press the switch on the steering wheel or touch .

To refuse to receive the call:

Press the switch on the steering wheel or touch .

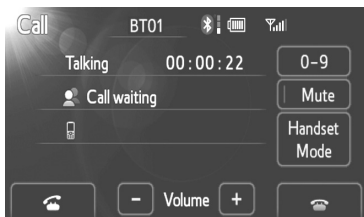

US3019DS

- Everytime you press the switch on the steering wheel or touch while interrupt call, the other party will be switched.

INFORMATION

- Interrupt call operation may differ depending on your phone company and cellular phone.
- Interrupt call is unavailable depending on the contract detail with the phone company.

1. QUICK REFERENCE

Fuel consumption information and tire pressure value can be displayed. To access the vehicle information system, press the “**CAR**” button.

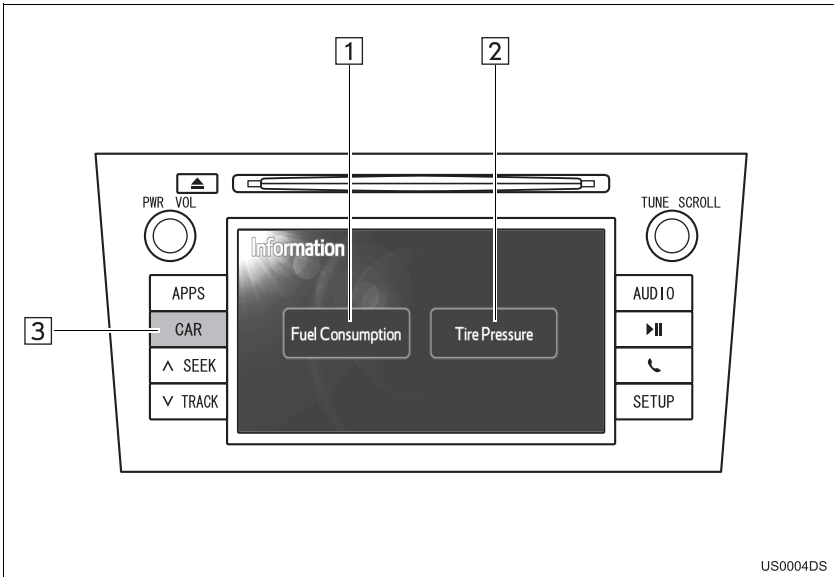

US0004DS

- The actual design and button position may differ depending on the vehicle. For details, see Section 3 of the vehicle “*Owner’s Manual*”.
- The “Information” screen shown above is displayed if the vehicle is equipped with both a fuel consumption and a tire pressure warning system.

No.	Name	Function	Page
1	“Fuel Consumption”*	Displays the “Trip Information”, “History” and “Energy Monitor” screen.	87
2	“Tire Pressure”*	Displays the “Tire Pressure” screen.	89
3	“CAR” button*	Press this button to access the vehicle information system.	87, 89

*: If equipped

2. FUEL CONSUMPTION*

FUEL CONSUMPTION
(VEHICLES WITH HYBRID
SYSTEM)

Fuel consumption such as shown below can be displayed on the screen. For details see Section 1-1 of the vehicle “Owner’s Manual”.

- Energy monitor
- Trip consumption
- History

FUEL CONSUMPTION
(VEHICLES WITH GASOLINE
ENGINE)

1 Press the “CAR” button.

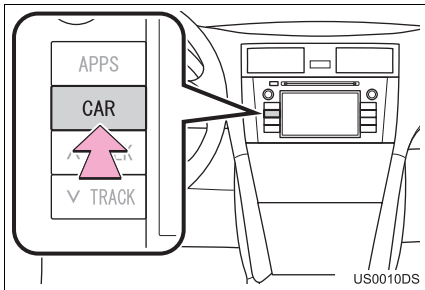

2 Touch “Fuel Consumption”.



- The “Trip Information” or “History” screen will be displayed.
- The “Information” screen is not displayed if the vehicles not equipped with a tire pressure warning system.

TRIP INFORMATION

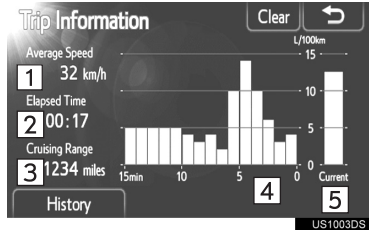

- If the “Trip Information” screen is not displayed, touch “Trip Information”.

No.	Name
1	Average speed
2	Elapsed time
3	Cruising range
4	Previous fuel consumption per minute
5	Current fuel consumption per minute

- “Clear”: Trip information data can be deleted by touching this screen button.
- “History”: “History” screen can be displayed by touching this screen button.

INFORMATION

- The trip information display indicates general driving conditions. Accuracy varies with driving habits and road conditions.

*: If equipped

HISTORY

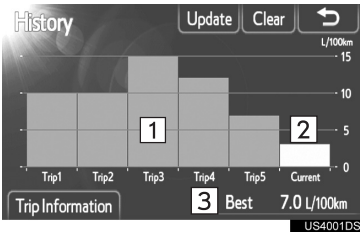

- If the “History” screen is not displayed, touch “**History**”.

No.	Name
1	Previous fuel economy record
2	Current fuel economy
3	Best recorded fuel economy

- The average fuel consumption history is divided by color into past averages and the average fuel consumption since the last reset.

“**Clear**”: Past record data can be deleted by touching this screen button.

“**Update**”: Reset the average fuel consumption to measure the current fuel consumption again.

► Vehicles with multi-information display

When you touch “**Update**”, the average fuel consumption displayed in the multi-information display will be reset at the same time.

“**Trip Information**”: “Trip Information” screen can be displayed by touching this screen button.

3. TIRE PRESSURE WARNING SYSTEM*

Vehicles equipped with a tire pressure warning system will display a warning screen in addition to a warning indication on the meter if tire pressure becomes low. For information on the tire pressure warning system, refer to the vehicle *“Owner’s Manual”*.

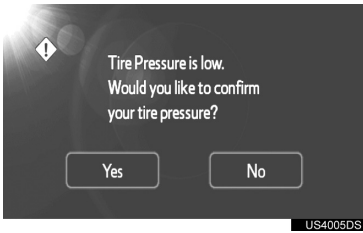

- To confirm tire pressure values, touch **“Yes”**. To cancel and return to the previous screen, touch **“No”**. (This screen will not be shown if the tire pressure screen is already being displayed.)

SHOWING THE TIRE PRESSURE SCREEN

The tire pressure value of each tire can be confirmed using the tire pressure screen.

- 1 Press the **“CAR”** button.

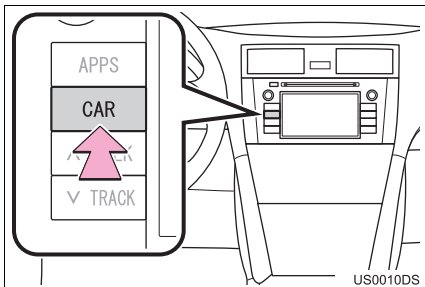

- 2 Touch **“Tire Pressure”**.

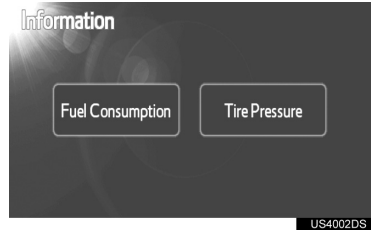

- 3 The tire pressure value of each tire will be displayed.

- ▶ Type A

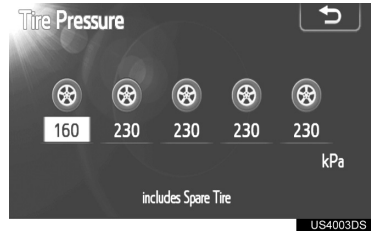

- ▶ Type B

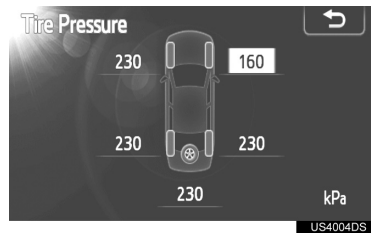

- Low tire pressure values will be displayed in orange.
- The display pattern varies depending on the vehicle. Some vehicles do not show the spare tire pressure.

*: If equipped

1. QUICK REFERENCE

To customize the function settings, press the **“SETUP”** button.

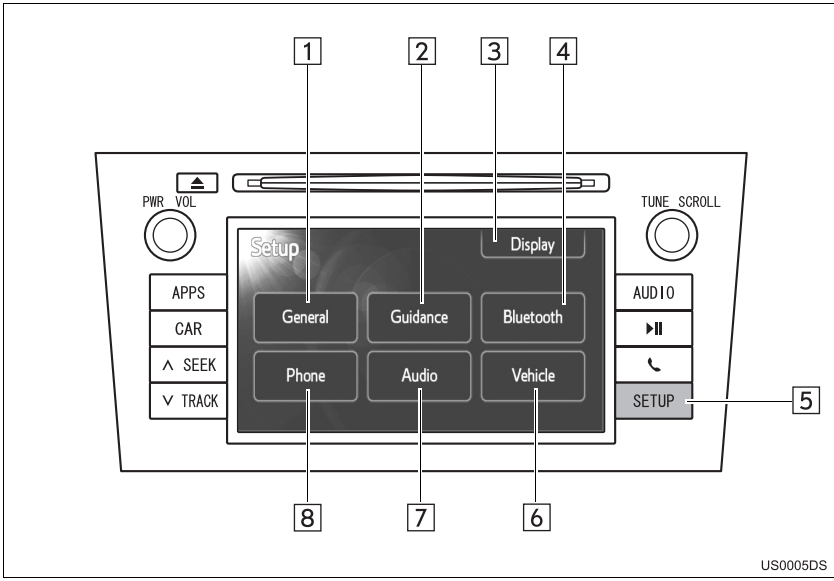

● The actual design and button position may differ depending on the vehicle. For details, see Section 3 of the vehicle *“Owner’s Manual”*.

No.	Name	Function	Page
1	“General”	Settings are available for language selection, operation sounds, screen animation, etc.	93
2	“Guidance” ^{*1}	Touch to set the voice guidance settings.	95
3	“Display”	Settings are available for contrast and brightness of the screen.	96
4	“Bluetooth” ^{*2}	Registering, removing, connecting and disconnecting Bluetooth® devices and settings are available for Bluetooth®.	98
5	“SETUP” button	Press this button to display the “Setup” screen.	93, 95, 96, 98, 106, 116, 117
6	“Vehicle” ^{*1}	Settings are available for vehicle customization.	117
7	“Audio” ^{*1}	Settings are available for HD Radio™ system.	116
8	“Phone”	Settings are available for phone sound, phone-book, etc.	106

^{*1}: Vehicles with Premium Display Audio system
^{*2}: Bluetooth is a registered trademark of Bluetooth SIG, Inc.

2. GENERAL SETTINGS

Settings are available for language selection, operation sounds, screen animation, etc.

1 Press the “**SETUP**” button.

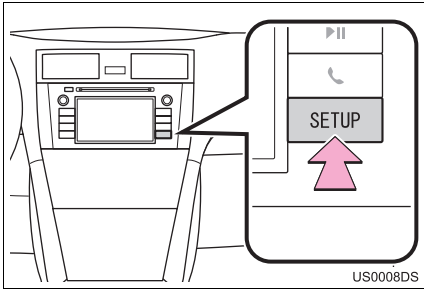

2 Touch “**General**”.



3 Touch the items to be set.

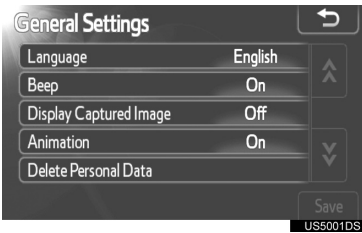

4 Touch “**Save**”.

SCREENS FOR GENERAL SETTINGS

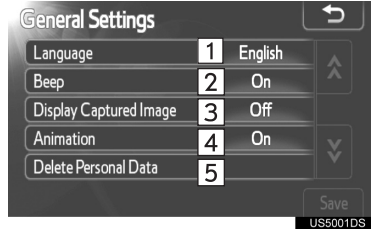

- On this screen, the following functions are operational.

No.	Function
1	You can change the language. (See “SELECTING A LANGUAGE” on page 94.)
2	“On” or “Off” can be selected to sound beeps.
3	“On” or “Off” can be selected to display capture image/iPod cover art in the screen.
4	The animation effect for audio source selection screen can be set to “On” or “Off”.
5	The personal data can be deleted. (See “DELETE PERSONAL DATA” on page 94.)

SELECTING A LANGUAGE

The desired language can be selected.

- 1 Press the **“SETUP”** button.
- 2 Touch **“General”** on the **“Setup”** screen.
- 3 Touch **“Language”**.

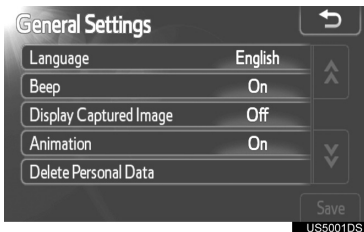

- 4 Touch the desired screen button.

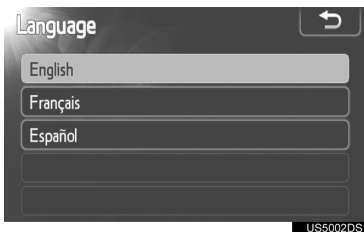

- The previous screen will be displayed.
- The selectable languages may differ depending on the model or region.

- 5 Touch **“Save”**.

DELETE PERSONAL DATA

- 1 Press the **“SETUP”** button.
- 2 Touch **“General”** on the **“Setup”** screen.
- 3 Touch **“Delete Personal Data”**.

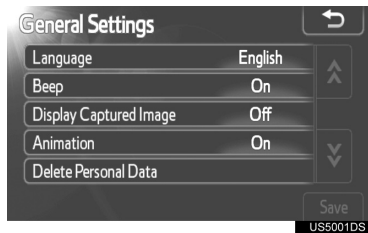

- 4 Touch **“Delete”**.

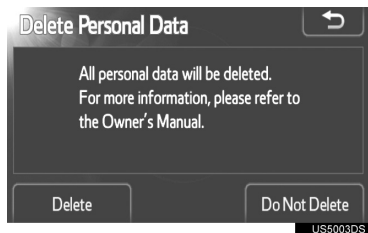

INFORMATION

- The following personal data can be deleted or returned to their default settings:
 - Phone book data
 - Call history data
 - Speed dial data
 - Bluetooth® devices data
 - Phone sound settings
 - Detailed Bluetooth® settings
 - Sound settings

3. GUIDANCE SETTINGS (WITH Premium Display Audio SYSTEM)

Voice recognition guidance for Bluetooth® hands-free systems can be set.

1 Press the “**SETUP**” button.

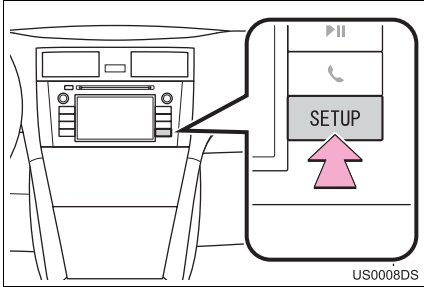

2 Touch “**Guidance**”.



3 Touch the items to be set.

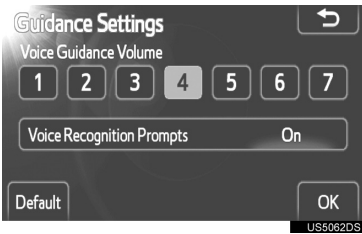

4 Touch “**OK**”.

SCREEN FOR VOICE GUIDANCE SETTINGS

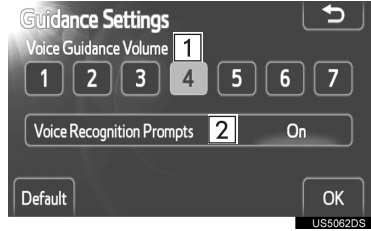

- On this screen, the following functions can be performed.

No.	Function
1	The voice guidance volume can be adjusted.
2	Voice recognition guidance can be set to “On” or “Off”.

5

SETUP

1. SETUP OPERATION

4. DISPLAY SETTINGS

You can adjust the contrast and brightness of the screen. You can also turn the display off.

- 1 Press the **“SETUP”** button.

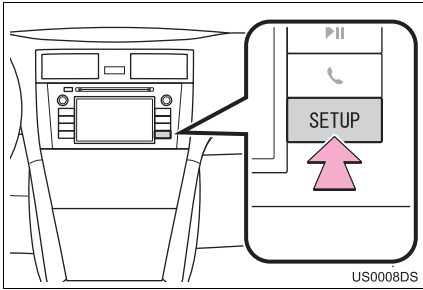

- 2 Touch **“Display”**.



- 3 Touch the items to be set.

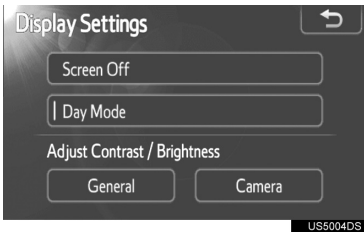

- Please refer to the following pages for each setting.

TURN OFF DISPLAY

- 1 Press the **“SETUP”** button.
- 2 Touch **“Display”** on the **“Setup”** screen.
- 3 Touch **“Screen Off”**.

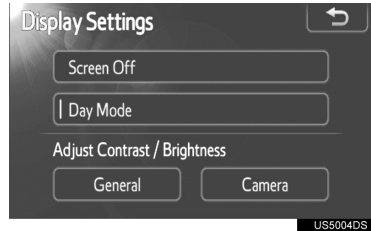

- The display screen will be turned off. To turn it on, press the **“AUDIO”**, **“CAR”** or **“SETUP”** button.

CHANGING BETWEEN DAY AND NIGHT MODE

Depending on the position of the headlight switch, the screen changes to day or night mode.

- 1 To display the screen in day mode even with the headlight switch on, touch **“Day Mode”** on the adjustment screen for brightness and contrast control.

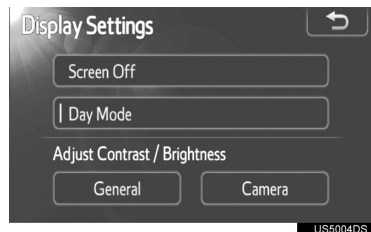

INFORMATION

- If the screen is set in day mode with the headlight switch turned on, this condition is memorized even with the engine turned off.

ADJUST CONTRAST/ BRIGHTNESS

- 1 Press the “**SETUP**” button.
- 2 Touch “**Display**” on the “Setup” screen.
- 3 Touch “**General**” or “**Camera**”, in which you want to make an adjustment.

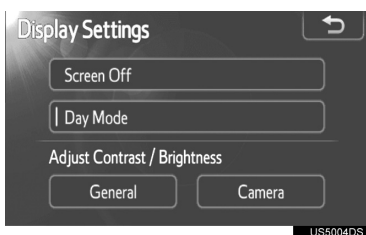

- 4 Select “**Contrast**” or “**Brightness**” using the << or >>.

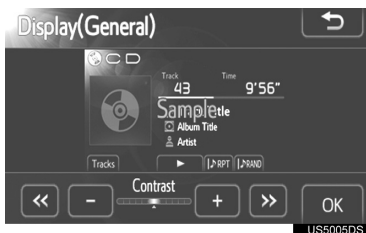

- 5 Adjust the contrast or brightness using the “+” or “-”.

Screen button	Function
“Contrast” “+”	Strengthens the contrast of the screen
“Contrast” “-”	Weakens the contrast of the screen
“Brightness” “+”	Brightens the screen
“Brightness” “-”	Darkens the screen

- 6 After adjusting the screen, touch “**OK**”.

1. SETUP OPERATION

5. Bluetooth® SETTINGS

You can confirm and change the Bluetooth® settings.

1 Press the “**SETUP**” button.

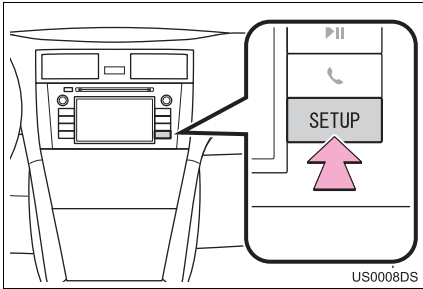

2 Touch “**Bluetooth**”.

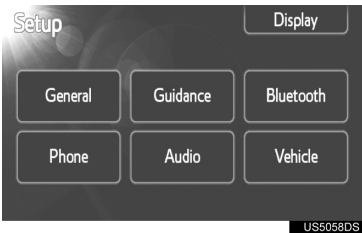

*: Bluetooth is a registered trademark of Bluetooth SIG, Inc.

3 Touch the items to be set.

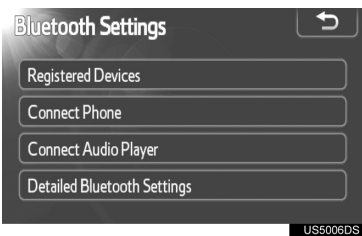

● Please refer to the following pages for each setting.

REGISTERED DEVICES

1 Press the “**SETUP**” button.

2 Touch “**Bluetooth**” on the “Setup” screen.

*: Bluetooth is a registered trademark of Bluetooth SIG, Inc.

3 Touch “**Registered Devices**”.

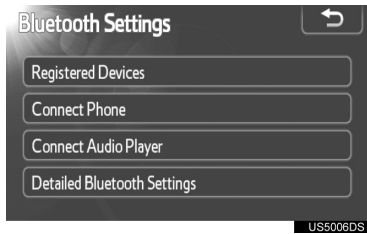

4 This screen is displayed.

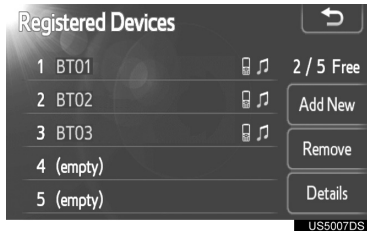

ADDING A NEW DEVICE

1 Touch “**Add New**” to register your Bluetooth® device to the system.

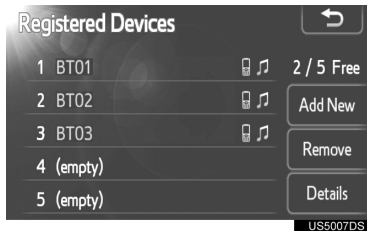

- 2 When this screen is displayed, perform a device discovery from your Bluetooth device.



- 3 Input the passcode displayed on the screen into your Bluetooth device.

- A passcode is not required for SSP (Secure Simple Pairing) compatible Bluetooth® phones. Depending on the type of Bluetooth® phone being connected, a message confirming registration may be displayed on the Bluetooth® phone's screen. Respond and operate the Bluetooth® phone according to the confirmation message.
- If you want to cancel it, touch **"Cancel"**.
- If the Bluetooth® phone to be registered has a Bluetooth® audio function, this can be registered at the same time.

- 4 When the connection is completed, this screen is displayed.



- Once you have registered it, the system automatically connects to your Bluetooth® device every time you start your vehicle.

INFORMATION

- For details on device discovery for your Bluetooth phone, refer to the Bluetooth phone's user's guide.
- When you register your phone, Bluetooth® audio will disconnect.
- If the Bluetooth® device has Bluetooth® phone and Bluetooth® audio functions, it will register phone and audio simultaneously. If an on-screen message appears, follow the message and register either or both Bluetooth® phone and/or Bluetooth® audio functions.

REMOVING A Bluetooth® DEVICE

- 1 Touch **"Remove"** to remove your Bluetooth® device from the system.

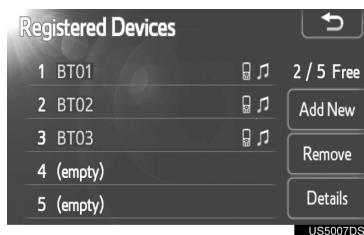

- 2 Select the device to remove.

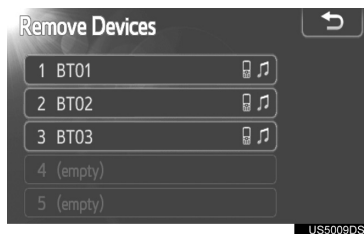

INFORMATION

- When you delete a Bluetooth® phone, the phonebook data will be deleted at the same time.

DISPLAYING DEVICE DETAILS

- 1 Touch **“Details”** to display a device detail.

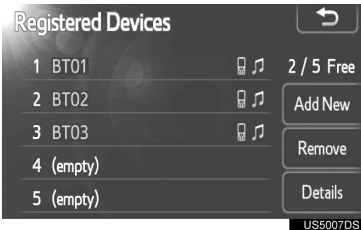

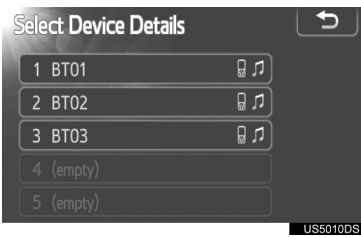

- 2 Select the device to display.

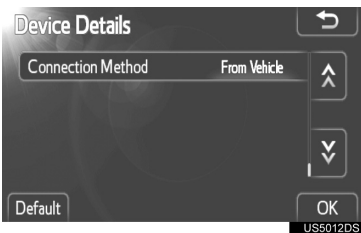
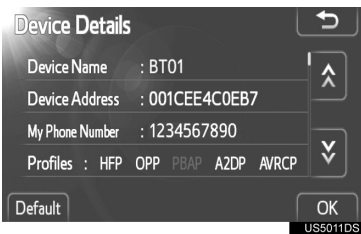

- 3 This screen is displayed.



- Touch  or  to scroll the list.
- The information displays the following items.

Name	Function
“Device Name”	The name in the Bluetooth® network.
“Device Address”	The address peculiar to the system. You cannot change it. If the same device name is displayed on the screen of your device, refer to it.
“My Phone Number”	Phone number of your phone. The number may not be displayed depending on the phones.
“Profiles”	The profiles which support your Bluetooth® device. (For details of each profile, see pages 49 and 70.)
“Connection Method”	The connection method can be switched between “From Vehicle” and “From Audio Player” .

CHANGING THE CONNECTION METHOD

The connection method can be selected.

- 1 Touch **“Connection Method”** and select **“From Vehicle”** or **“From Audio Player”**.

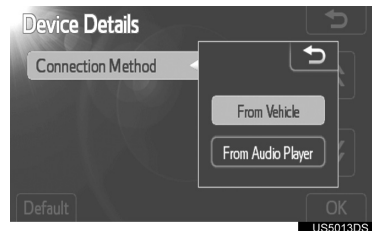

2 Touch “OK”.

“**From Vehicle**”: Connect the audio system to the portable audio player.

“**From Audio Player**”: Connect the portable audio player to the audio system.

INITIALIZING THE Bluetooth® SETTINGS

You can initialize the settings.

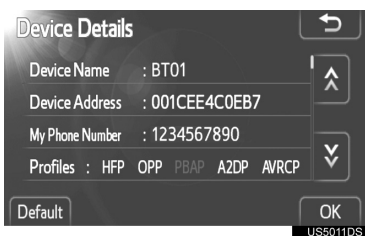
1 Touch “Default”.

CONNECT PHONE

In case you register more than one Bluetooth® device, you need to choose a favorite one.

You can select the Bluetooth® device from a maximum of 5 numbers.

1 Press the “SETUP” button.**2** Touch “Bluetooth*” on the “Setup” screen.

*: Bluetooth is a registered trademark of Bluetooth SIG, Inc.

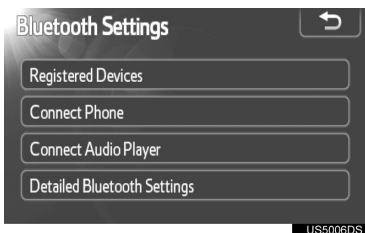
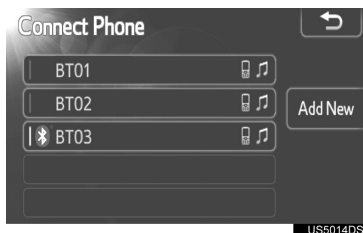
3 Touch “Connect Phone”.**4** Select the device to connect.

- The Bluetooth® mark is displayed when you connect the device.

- When you touch the device name with the selection indicator and the Bluetooth® mark, the device will be disconnected.

5 When the connection is completed, this screen is displayed.

CONNECT AUDIO PLAYER

In case you register more than one Bluetooth® device, you need to choose a favorite one.

You can select the Bluetooth® device from a maximum of 5 numbers.

1 Press the “SETUP” button.**2** Touch “Bluetooth*” on the “Setup” screen.

*: Bluetooth is a registered trademark of Bluetooth SIG, Inc.

3 Touch “Connect Audio Player”.

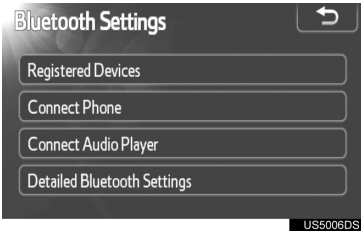

4 Select the device to connect.



- The Bluetooth® mark is displayed when you connect the device.
- When you touch the device name with the selection indicator and the Bluetooth® mark, the device will be disconnected.

5 When the connection is completed, this screen is displayed.

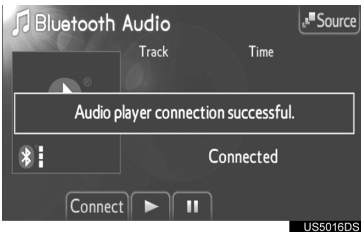

DETAILED Bluetooth® SETTINGS

- 1** Press the “SETUP” button.
- 2** Touch “Bluetooth*” on the “Setup” screen.
- 3** Touch “Detailed Bluetooth* Settings”.

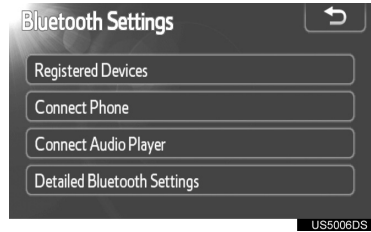

*: Bluetooth is a registered trademark of Bluetooth SIG, Inc.

4 This screen is displayed.

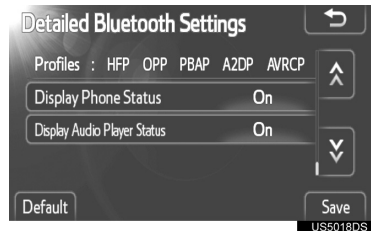
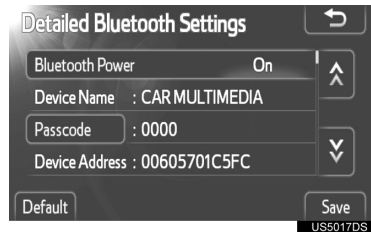

- Touch  or  to scroll the list.

- The information displays the following items.

Name	Function
"Bluetooth* Power"	It is available to set whether registered devices will be connected automatically or not.
"Device Name"	The name in the Bluetooth® network. You cannot change it.
"Passcode"	The password when you register your Bluetooth device in the system. You can change it.
"Device Address"	The address peculiar to the system. You can not change it.
"Profiles"	The name of the profile which your Bluetooth® device corresponds to. (For details of each profile, see pages 49 and 70.)
"Display Phone Status"	The Bluetooth® phone connection status. You can turn it on and off.
"Display Audio Player Status"	The portable audio player connection status. You can turn it on and off.

- If you want to change the settings, refer to the following pages.
- When you change the settings, touch **"Save"** after changing them.

*: Bluetooth is a registered trademark of Bluetooth SIG, Inc.

CHANGING THE Bluetooth® POWER

1 Touch "Bluetooth* Power".

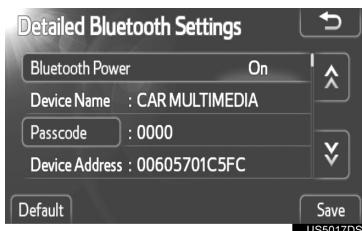

2 Touch "On" or "Off".

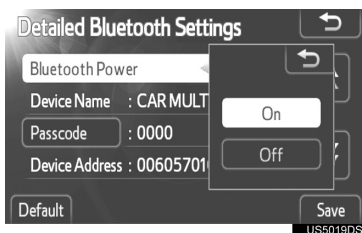

3 Touch "Save".

- In case that the state of **"Bluetooth* Power"** is changed from **"Off"** into **"On"**, Bluetooth® connection will begin.
- The **"Bluetooth* Power"** display shows the following state.

When **"Bluetooth* Power"** is **"On"**: The Bluetooth® device is automatically connected when you start your vehicle.

When **"Bluetooth* Power"** is **"Off"**: The Bluetooth® device is disconnected, and the system will not connect to it next time.

- You can select the state of **"Bluetooth* Power"**.

On: The automatic connection is turned on.

Off: The automatic connection is turned off.

*: Bluetooth is a registered trademark of Bluetooth SIG, Inc.

EDITING THE PASSCODE

1 Touch “Passcode”.

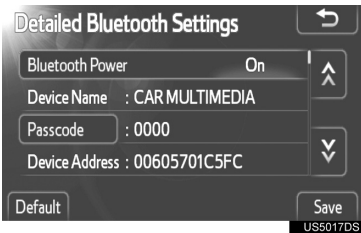

2 Input a passcode and touch “OK”.

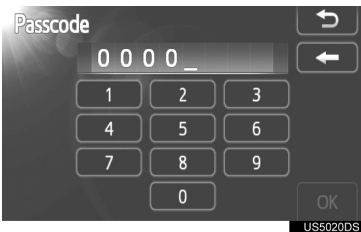

CHANGING THE DISPLAY PHONE STATUS

1 Touch “Display Phone Status”.

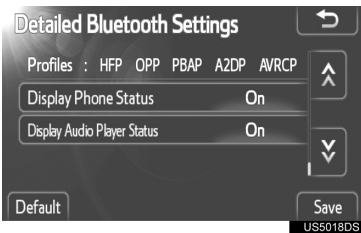

2 Touch “On” or “Off”.

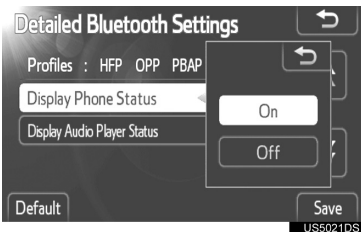

3 Touch “Save”.

- When you start your vehicle and the Bluetooth® phone is automatically connected, the connection check is displayed.

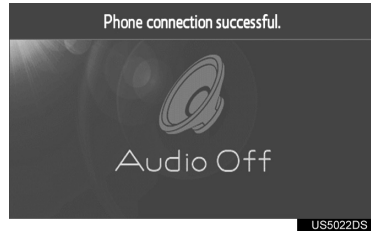

- You can select the state of “Display Phone Status”.

On: The status is displayed.

Off: The status is not displayed.

CHANGING THE DISPLAY AUDIO PLAYER STATUS

1 Touch “Display Audio Player Status”.

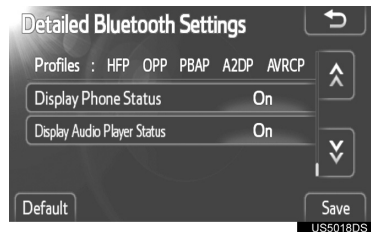

2 Touch “On” or “Off”.

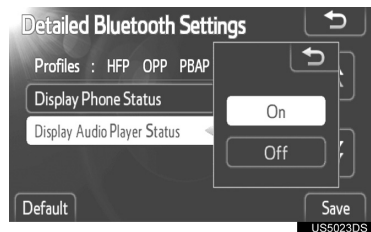

3 Touch “Save”.

- When you start your vehicle and the Bluetooth® portable audio player is automatically connected, the connection check is displayed.



- You can select the state of “**Display Audio Player Status**”.

On: The status is displayed.

Off: The status is not displayed.

INITIALIZING THE Bluetooth® SETTINGS

You can initialize the settings.

- 1 Touch “**Default**”.

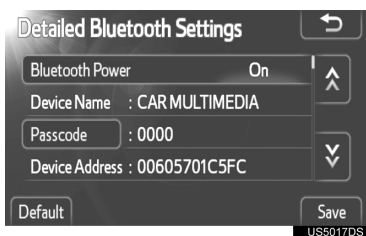

- If the state of “**Bluetooth* Power**” is changed from “**Off**” into “**On**”, Bluetooth® connection will begin.

*: Bluetooth is a registered trademark of Bluetooth SIG, Inc.

6. PHONE SETTINGS

Phone settings can be changed.

- 1 Press the **“SETUP”** button.

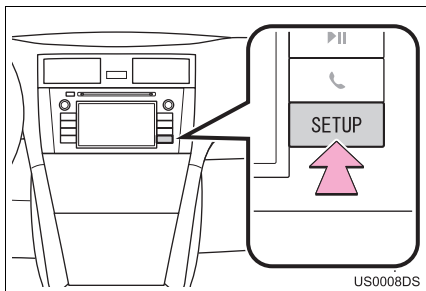

- 2 Touch **“Phone”**.



- 3 Touch the items to be set.

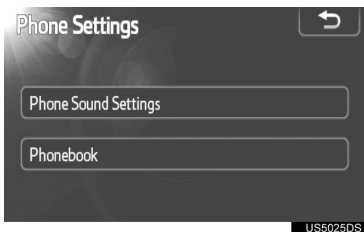

- Please refer to the following pages for each setting.

PHONE SOUND SETTINGS

- 1 Touch **“Phone Sound Settings”**.

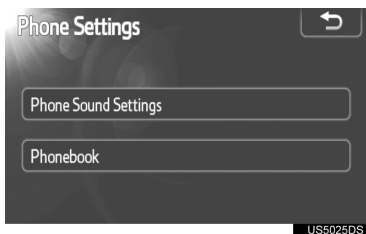

- 2 Change each setting according to the following procedures.

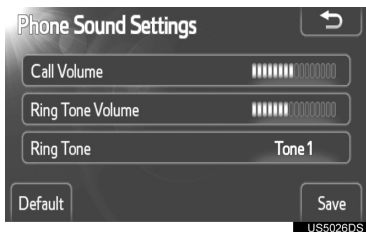

- 3 When you complete all settings, touch **“Save”**.

CALL VOLUME SETTING

- 1 Touch **“Call Volume”**.
- 2 Touch **“-”** or **“+”** to adjust the call volume.

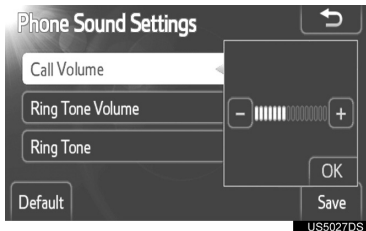

- 3 Touch **“OK”**.

RING TONE VOLUME SETTING

- 1 Touch “Ring Tone Volume”.
- 2 Touch “-” or “+” to adjust the ring volume.

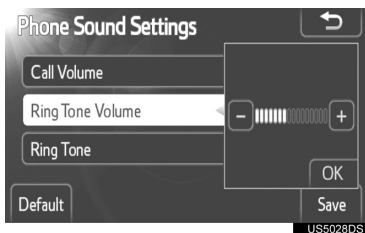

- 3 Touch “OK”.

RING TONE SELECTING

- 1 Touch “Ring Tone”.
- 2 Touch “Tone 1”, “Tone 2” or “Tone 3”.

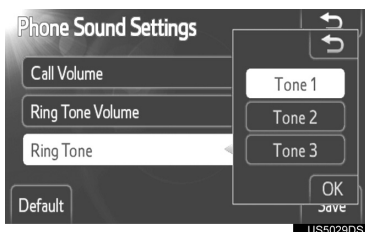

- 3 Touch “OK”.

INITIALIZING THE SETTINGS

You can initialize the settings.

- 1 Touch “Default”.

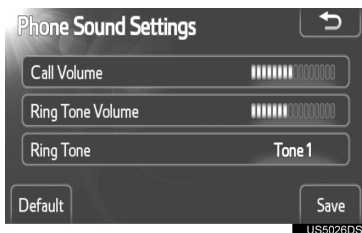

PHONEBOOK

- 1 Press the “SETUP” button.
- 2 Touch “Phone”.
- 3 Touch “Phonebook”.

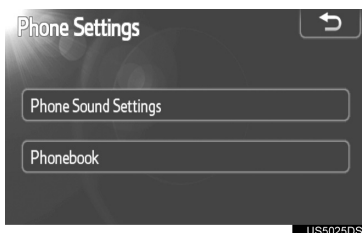

- 4 Touch the items to be set.

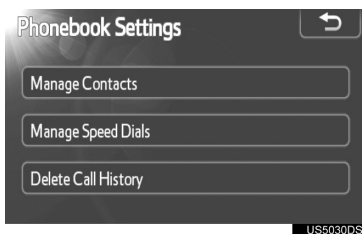

- Please refer to the following pages for each setting.

INFORMATION

- Phonebook data is managed for every registered phone. When another phone is connecting, you cannot read the registered data.

PHONEBOOK SETTINGS

- 1 Touch “Manage Contacts”.

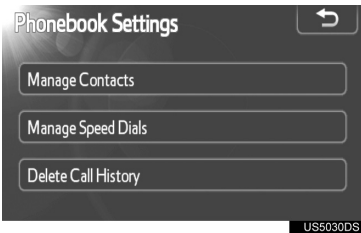

- 2 Touch the items to be set.

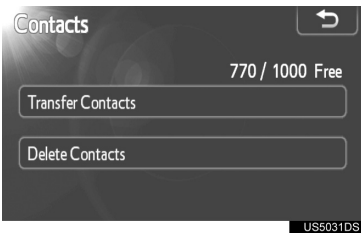

- Please refer to the following pages for each setting.

TRANSFERRING A PHONE NUMBER

You can transfer the phone numbers in your Bluetooth® phone to the system. The phonebook manages a maximum of 5 phonebooks each. Up to 1000 person's data (up to 3 numbers a person) can be registered in each phonebook.

Operation methods differ between PBAP compatible and PBAP incompatible but OPP compatible Bluetooth® phones.

If your cellular phone is neither PBAP nor OPP compatible, the phonebook cannot be transferred.

- 1 Touch “Transfer Contacts”.

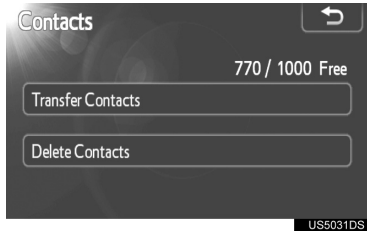

- ▶ PBAP compatible models

- 2 This screen is displayed. (See page 109.)

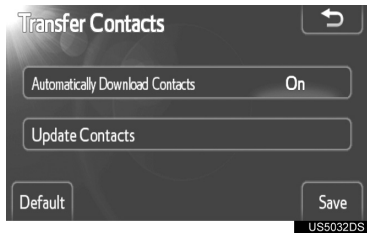

- ▶ PBAP incompatible but OPP compatible models

- 2 This screen is displayed. (See page 110.)

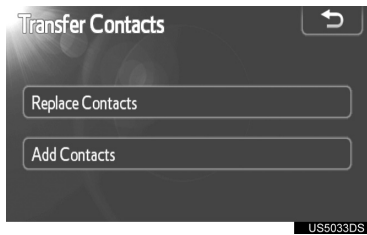



- To verify which profile the cellular phone has, confirm the “Detailed Bluetooth* Settings” screen. (See “DETAILED Bluetooth® SETTINGS” on page 102.)

*: Bluetooth is a registered trademark of Bluetooth SIG, Inc.

INFORMATION

- Transfer it while the engine is running.
- Depending on the cellular phone, call history will be also transferred.
- When transferring the phonebook data to the cellular phone, the hands-free may be unavailable.

- You can also display the “Transfer Contacts” screen in the following way.

- 1 Press the  switch on the steering wheel or the  button.
- 2 Touch “Contacts”.
- 3 Touch “Transfer”.



■ AUTOMATIC PHONEBOOK DOWNLOAD SETTING (PBAP COMPATIBLE MODELS)

The first time when the Bluetooth® phone is connected when you start your vehicle, phonebook data is automatically transferred to the system.

The phonebook data will also be transferred automatically when the phone is switched over.

- 1 Touch “Automatically Download Contacts” and select “On” or “Off”.

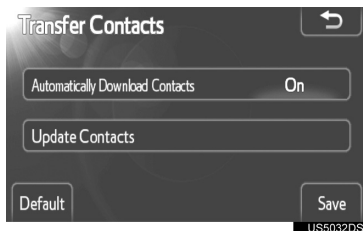

- 2 Touch “Save”.

- When the automatic transferring fails, on-screen message will be displayed. Operate by following the display.

INFORMATION

- If you try to manually transfer when transferring automatically, progression display on automatic transfer will be displayed.
- The old phonebook data is available during the transfer on new phonebook data.

■ UPDATE CONTACTS (PBAP COMPATIBLE MODELS)

You can update contacts.

- 1 Touch “Update Contacts”.

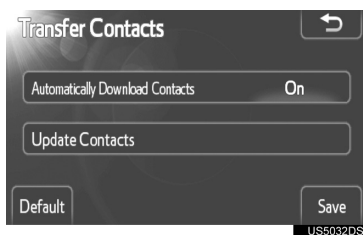

2 Transfer the phonebook data to the system using the Bluetooth® phone.

- Depending on the type of cellular phone, OBEX authentication may be required when transferring phonebook data. Enter “1234” into the Bluetooth® phone.



- This screen appears while transferring. To cancel it, touch “**Cancel**”. If the transferring is interrupted on the way, the phonebook data transferred will be deleted.

REPLACE OR ADD CONTACTS (PBAP INCOMPATIBLE BUT OPP COMPATIBLE MODEL)

1 Touch “**Replace Contacts**” when you want to replace contacts, or touch “**Add Contacts**” when you want to add contacts.

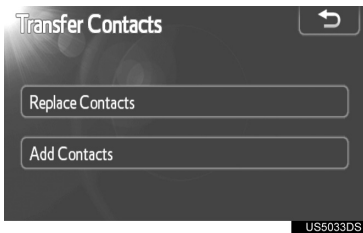

2 Transfer the phonebook data to the system using the Bluetooth® phone.

- Depending on the type of cellular phone, OBEX authentication may be required when transferring phonebook data. Enter “1234” into the Bluetooth® phone.



- This screen appears while transferring. To cancel it, touch “**Cancel**”. If the transferring is interrupted on the way, when the phone supports OPP service, the phonebook data transferred until then can be memorized in the system.

INFORMATION

- Bluetooth® audio may be disconnected during transfer on phonebook data.

DELETING THE PHONEBOOK DATA

You can delete the data.

When you release your car, delete all your data on the system.

For PBAP compatible phone, delete the phonebook data after setting “Automatically Download Contact” to “Off”. (See “AUTOMATIC PHONEBOOK DOWNLOAD SETTING” on page 109)



1 Touch “Delete Contacts”.



2 Select the name you want to delete or touch “All Delete”.



- You can also delete it in the following way.

- 1 Press the  switch on the steering wheel or the  button.
- 2 Touch “Contacts”.
- 3 Select the name from the list.
- 4 Touch “Options”.

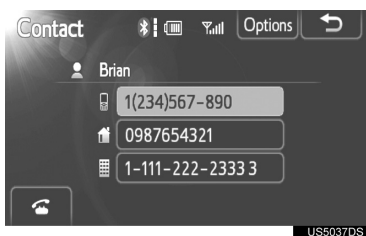

5 Touch “Delete”.

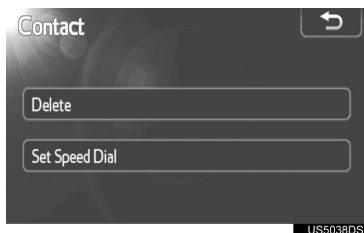
**INFORMATION**

- When you delete a Bluetooth® phone, the phonebook data will be deleted at the same time.

SPEED DIALS SETTING

Speed dials setting is accessed from the “Speed Dials” screen.

- 1 Press the “SETUP” button.
- 2 Touch “Phone”.
- 3 Touch “Phonebook”.
- 4 Touch “Manage Speed Dials”.

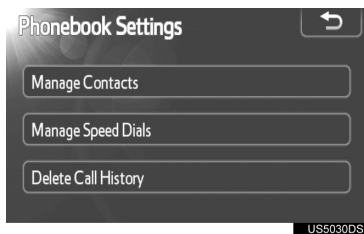

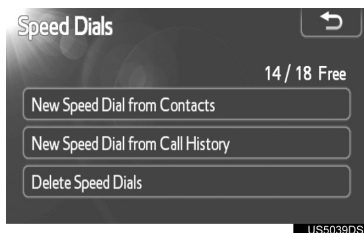

5 Touch the items to be set.



- Please refer to the following pages for each setting.



- You can also display the “Speed Dials” screen in the following way.

► From “Speed Dial” screen

- 1 Press the  switch on the steering wheel or the  button.
- 2 Touch “Speed Dials”.
- 3 Touch “Options”.



► From “Contacts” screen

- 1 Press the  switch on the steering wheel or the  button.
- 2 Touch “Contacts”.
- 3 Touch “Options”.



- 4 Touch “Manage Speed Dials”.

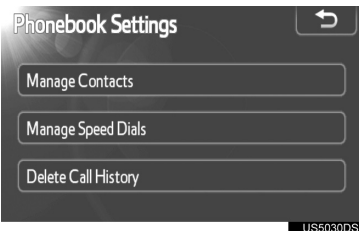

REGISTERING THE SPEED DIAL FROM CONTACTS

You can register the phone number from phonebook. Up to 18 numbers per phone can be registered.

- 1 Touch “New Speed Dial from Contacts”.

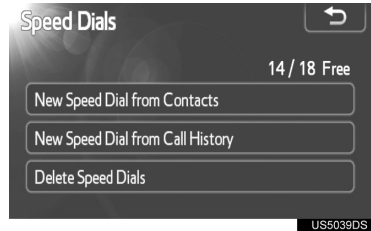

- 2 Select the data you want to register.



- 3 Touch the desired phone number.

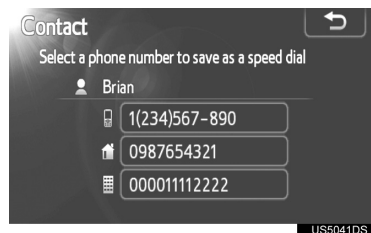

- 4 Touch the screen button you want to register in.

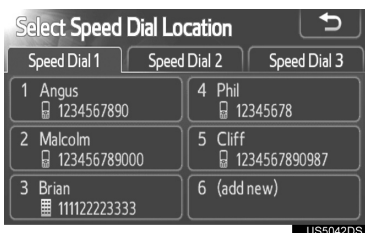

REGISTERING THE SPEED DIAL FROM CALL HISTORY

- 1 Touch “New Speed Dial from Call History”.

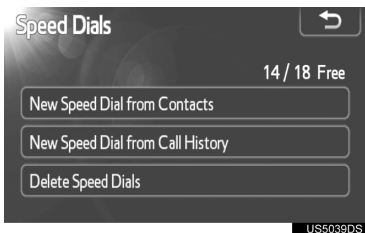

- 2 Select the data you want to register.



- 3 Touch the screen button you want to register in.

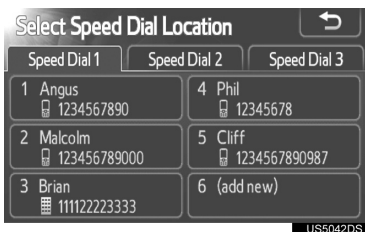

- You can also register the speed dial in the following ways.

► From “Speed Dial” screen

- Press the switch on the steering wheel or the button.
- Touch “Speed Dials”.
- Touch “(add new)”.



- 4 Touch any screen button you want to register from.



- 5 Select the data you want to register.



6 Touch the desired phone number.



► From “Contact” screen

- 1** Press the switch on the steering wheel or the button.
- 2** Touch “Contacts”.
- 3** Select the data from the list.
- 4** Touch “Options”.

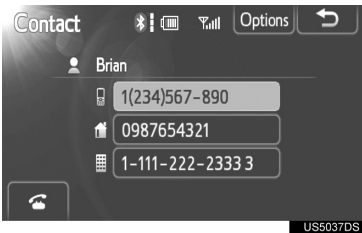

5 Touch “Set Speed Dial”.

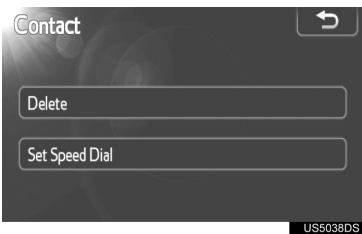

6 Touch the desired phone number.

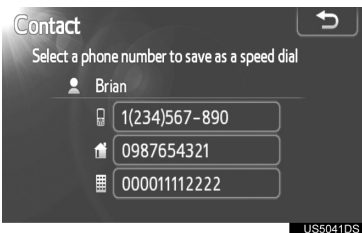

► From “Call History” screen

- 1** Press the switch on the steering wheel or the button.
- 2** Touch “Call History”.
- 3** Touch the desired phone number.
- 4** Touch “Add Speed Dial”.

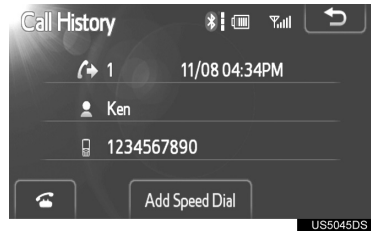

■ DELETING THE SPEED DIAL

You can delete the speed dial.

1 Touch “Delete Speed Dials”.

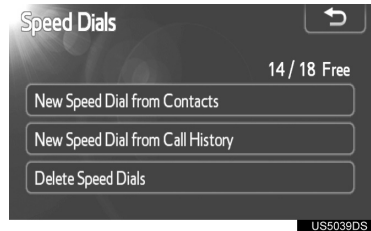

2 Select the data you want to delete or touch “All Delete”.

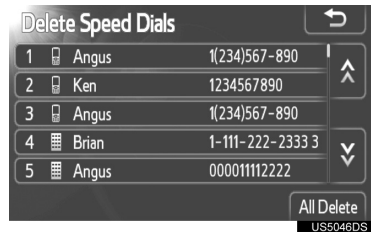

DELETING CALL HISTORY

You can delete the call history.

For PBAP compatible phone, delete the phonebook data after setting “Automatically Download Contact” to “Off”. (See “AUTOMATIC PHONEBOOK DOWNLOAD SETTING” on page 109)

- 1 Touch “Delete Call History”.

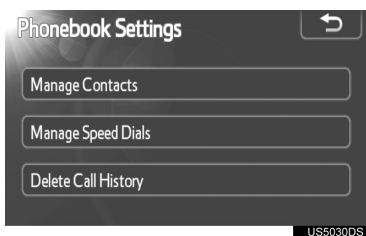

- 2 Select the desired history to delete.



- 3 Select the data you want to delete or touch “All Delete”.

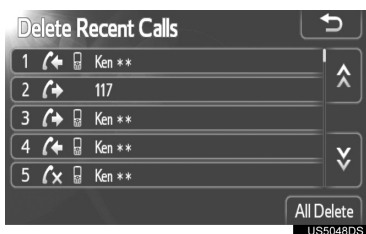

- You can also delete the call history in the following way.

- 1 Press the switch on the steering wheel or the button.
- 2 Touch “Call History”.
- 3 Touch “Delete”.

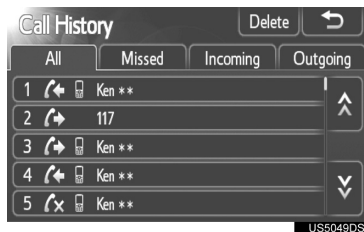

- 4 Select the data you want to delete or touch “All Delete”.

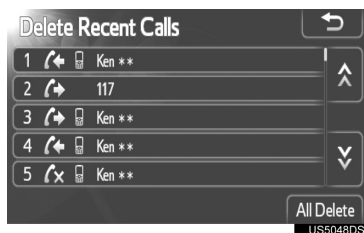

1. SETUP OPERATION

7. AUDIO SETTINGS (WITH Premium Display Audio SYSTEM)

HD Radio™ system can be set using the following procedure:

1 Press the “**SETUP**” button.

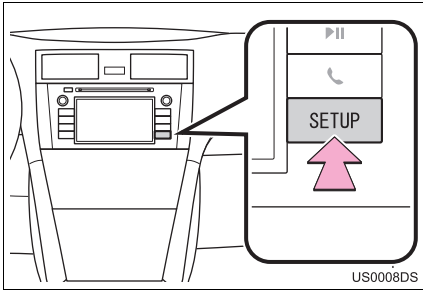

2 Touch “**Audio**”.



3 Touch “**HD Radio Settings**”.

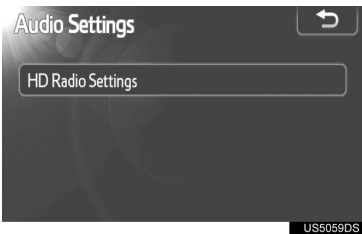

4 Select the desired setting from “**HD Radio/Analog Setting**”.

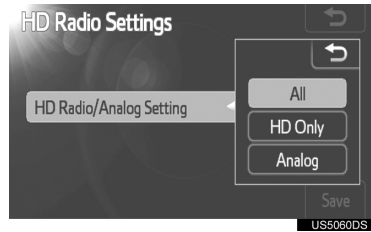

Screen button	Function
“All”	Touch to receive both analog and digital broadcasts.
“HD Only”	Touch to receive only digital broadcasts.
“Analog”	Touch to receive only analog broadcasts.

5 Touch “**Save**”.

8. VEHICLE SETTINGS*

Vehicle customization settings can be changed.

1 Press the “**SETUP**” button.

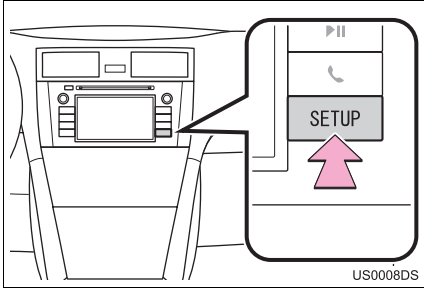

2 Touch “**Vehicle**”.



3 Touch the desired items to be set.

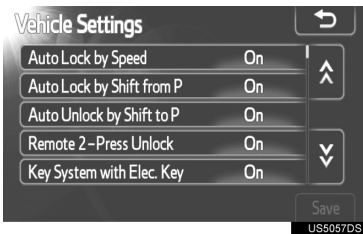

● For a list of the settings that can be changed, see the vehicle “*Owner’s Manual*”.

4 After changing the settings, touch “**Save**”.

● A message indicating that the settings are being saved will appear. Do not perform any other operations while this message is displayed.

*: If equipped

1. REAR VIEW MONITOR SYSTEM OPERATION

The rear view monitor system assists the driver by displaying an image of the view behind the vehicle while backing up.

The image is displayed in reverse on the screen. This allows the image to appear in the same manner as that of the rear view mirror.

- 1 To display the rear view image on the screen, the shift lever is in the "R" position when the engine switch is in the "ON" position.
- If you move the shift lever out of the "R" position, the screen returns to the previous screen.



CAUTION

- Never depend on the rear view monitor system entirely when backing up. Always make sure your intended path is clear.
Use caution, just as you would when backing up any vehicle.
- Never back up while looking only at the screen. The image on the screen is different from actual conditions. Depicted distances between objects and flat surfaces will differ from the actual distances. If you back up while looking only at the screen, you may hit a vehicle, a person or an object. When backing up, be sure to check behind and all around the vehicle visually and with mirrors before proceeding.
- Do not use the system when the back door, trunk or tailgate is not completely closed.
- Use your own eyes to confirm the vehicle's surroundings, as the displayed image may become faint or dark, and moving images will be distorted, or not entirely visible when the outside temperature is low. When backing up, be sure to check behind and all around the vehicle visually and with mirror before proceeding.
- Do not use the system in the following cases:
 - On icy or slick road surfaces, or in snow.
 - When using tire chains or emergency tires.
 - On an uneven road, such as a slope.
- ▶ With rear view monitor guide lines (If equipped)
 - Always check the vehicle surrounding area, because the guide lines are ancillary lines.
 - The guide lines are ancillary lines and do not change even if the steering wheel is turned.

NOTICE

- If the back of the vehicle is hit, the position and mounting angle of the camera may change. Be sure to have the camera's position and mounting angle checked at your Toyota dealer.
- As the camera has a water proof construction, do not detach, disassemble or modify it. This may cause incorrect operation.
- If the temperature changes rapidly, such as when hot water is poured on the vehicle in cold weather, the system may not operate normally.
- Do not strongly rub the camera lens. If the camera lens is scratched, it can not transmit a clear image.
- Do not allow organic solvent, car wax, window cleaner or glass coat to adhere to the camera. If this happens, wipe it off as soon as possible.
- If the tire size is changed, the area displayed on the screen may change.
- When washing the vehicle, do not apply intensive bursts of water to the camera or camera area. Doing so may result in the camera malfunctioning.

INFORMATION

- If the camera lens becomes dirty, it cannot transmit a clear image. If water droplets, snow, or mud adhere to the lens, rinse with water and wipe with a soft cloth. If the lens is extremely dirty, wash it with a mild cleanser and rinse.

REAR VIEW MONITOR GUIDE LINES (IF EQUIPPED)

Guide lines are displayed on the screen.

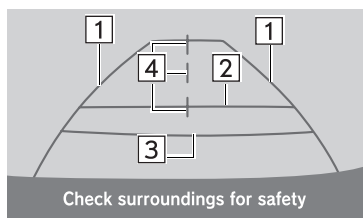

US0030DS

- Guidelines shown differ from those shown on the actual screen.
- 1 Vehicle width extension guide lines (blue)**
 - These lines indicate the estimated vehicle width extension.
 - 2 Distance guide line (blue)**
 - This line indicates a position on the ground about 3 ft. (1 m) behind on the ground of the rear bumper of the vehicle.
 - 3 Distance guide line (red)**
 - This line indicates a position on the ground about 1.5 ft. (0.5 m) behind on the ground of the rear bumper of the vehicle.
 - 4 Vehicle center guide lines (blue)**
 - These lines indicate the estimated vehicle center on the ground.

AREA DISPLAYED ON SCREEN

Image is displayed approximately level on screen.

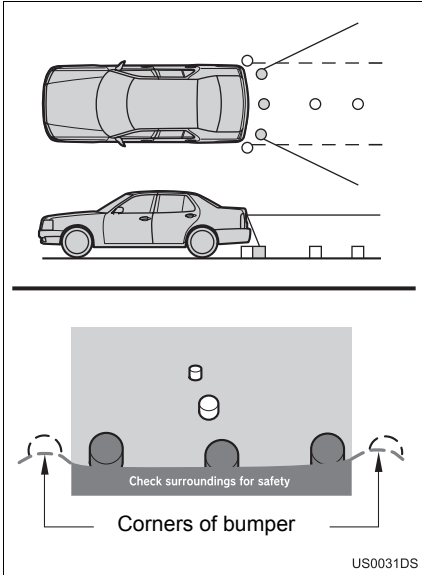

INFORMATION

- The area detected by the camera is limited. The camera does not detect objects which are close to either corner of the bumper or under the bumper.

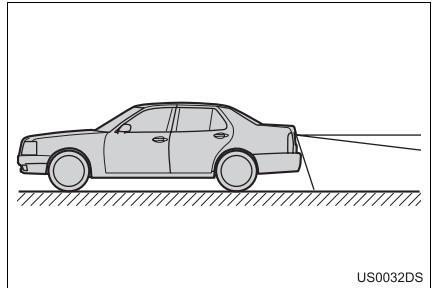

INFORMATION

- The area displayed on the screen may vary according to vehicle orientation or road conditions.

THE REAR VIEW MONITOR SYSTEM CAMERA

The rear view monitor system camera is located as shown in the illustration.

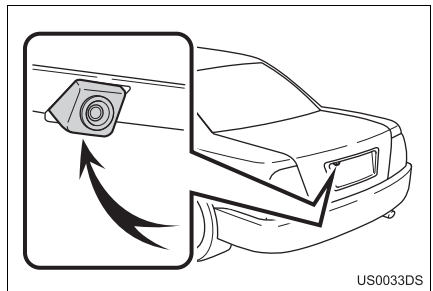

- The actual camera location may differ depending on the vehicle. For details, see the pictorial index of the vehicle "Owner's Manual".

INFORMATION

- The camera uses a special lens. The distance of the image that appears on the screen differs from the actual distance.
- In the following cases, it may become difficult to see the images on the screen, even when the system is functioning.
 - In the dark (for example, at night)
 - When the temperature near the lens is high or low
 - When water droplets are adhering to the camera, or when humidity is high (for example, when it rains)
 - When foreign matter (for example, snow or mud) is adhering to the camera
 - When the camera has scratches or dirt on it
 - When the sun or the beam of headlights is shining directly into the camera lens
- When the camera is used under fluorescent lights, sodium lights, or mercury lights etc., the lights and the illuminated areas may appear to flicker.

▶ On some models



If a bright light (for example, sunlight reflected off the vehicle body) is picked up by the camera, the smear effect* peculiar to the camera may occur.

*: Smear effect — A phenomenon that occurs when a bright light (for example, sunlight reflected off the vehicle body) is picked up by the camera; when transmitted by the camera, the light source appears to have a vertical streak above and below it.

2. DRIVING PRECAUTIONS (WITH REAR VIEW MONITOR GUIDE LINES)

In any of the following situations, there is a margin of error between the guide lines on the screen and the actual distance/course on the road.

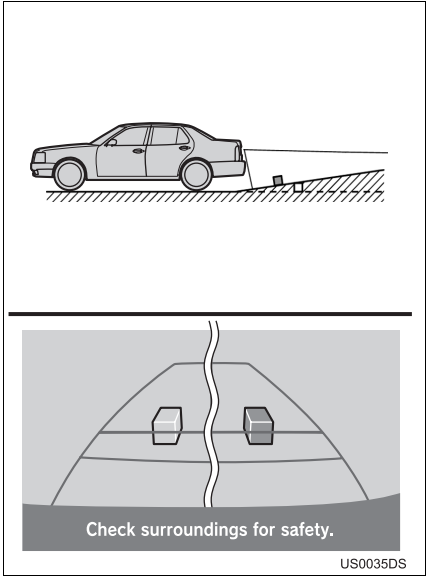

- When the grade behind the vehicle slopes up sharply, objects appear to be farther away than they actually are.

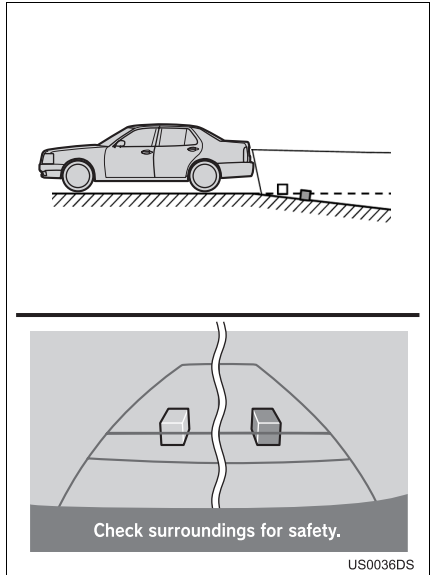

- When the grade behind the vehicle slopes down sharply, objects appear to be closer than they actually are.

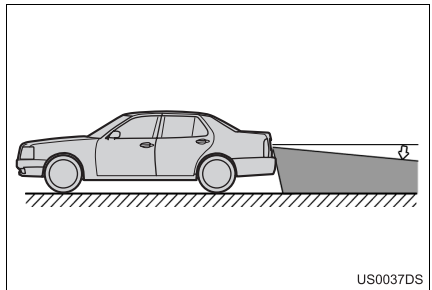

- When any part of the vehicle sags due to the number of passengers or the distribution of the load, there is a margin of error between the guide lines on the screen and the actual distance/course on the road.

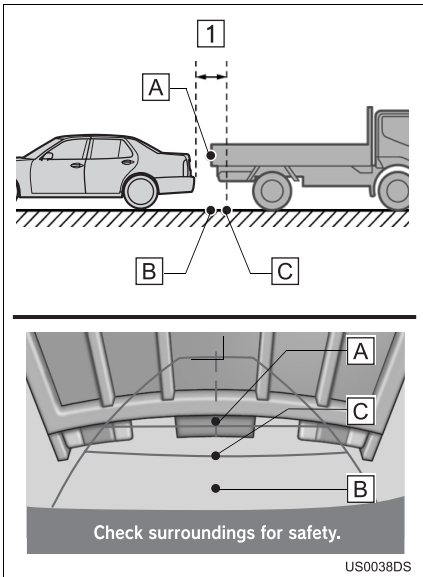

1 Approx. 1.5 ft. (0.5 m)

The distance that appears on the screen between three-dimensional objects (such as vehicles) and flat surfaces (such as the road) and the actual distance differ as follows.

- In reality, $A = B < C$ (A and B are equally far away; C is farther than A and B). However, on the screen, the situation appears to be $B < C < A$.
- On the screen, it appears that a truck is parking approximately 1.5 ft. (0.5 m) away. However, in reality if you back up to point B , you will hit the truck.

