

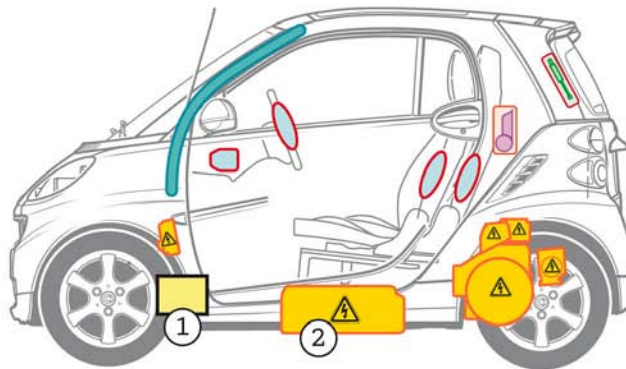

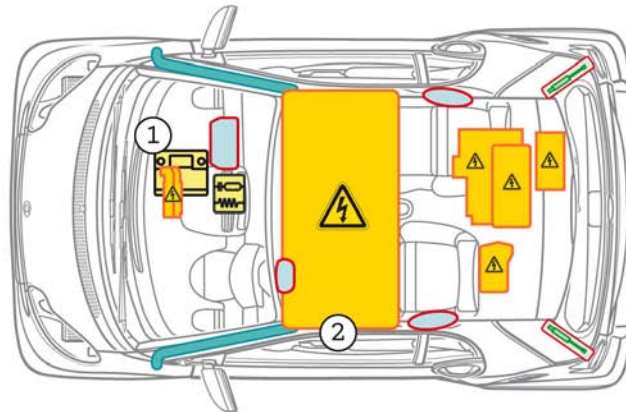







*smart fortwo
coupé
electric drive
(model 451)*

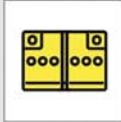

- 1 12 V battery
- 2 High-voltage battery

Legend

	Airbag		Body reinforcement		Control unit
	Gas generator		Roll-over protection		Battery
	Emergency tensioning retractor		Gas-filled strut		High-voltage components

smart fortwo

*smart fortwo
cabrio
electric drive
(model 451)*

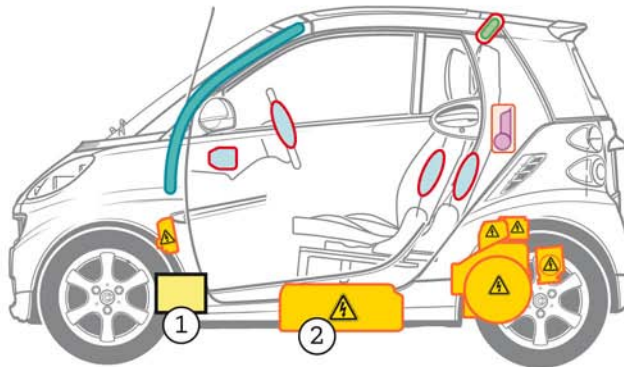
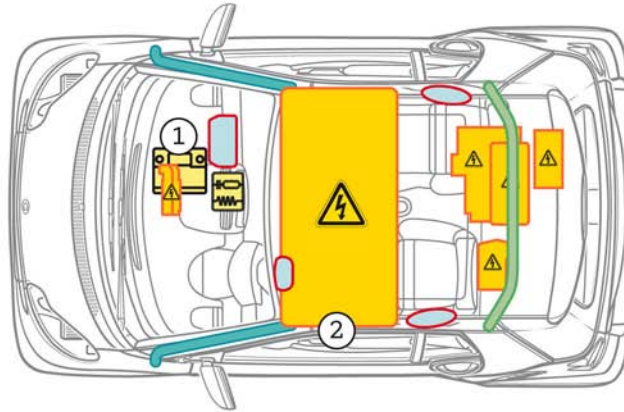

- 1 12 V battery
- 2 High-voltage battery

Legend



Airbag



Body reinforcement



Control unit



Gas generator



Roll-over protection

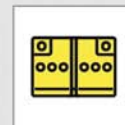

Battery



Emergency tensioning retractor



Gas-filled strut



High-voltage components