

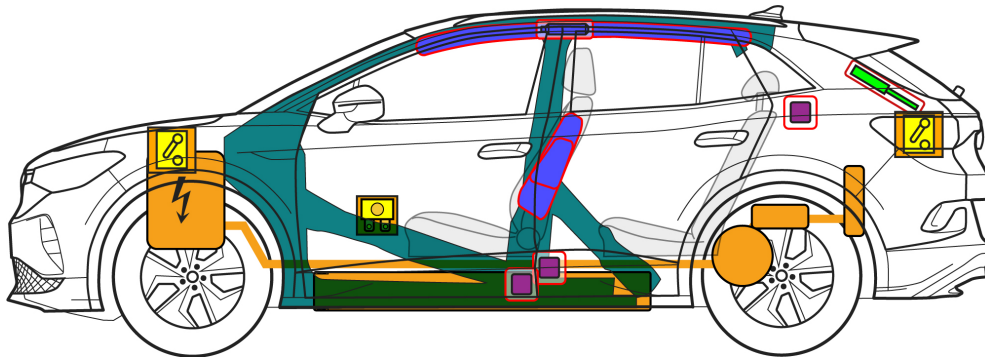

# Volkswagen ID.4

5-door model, as of 2020

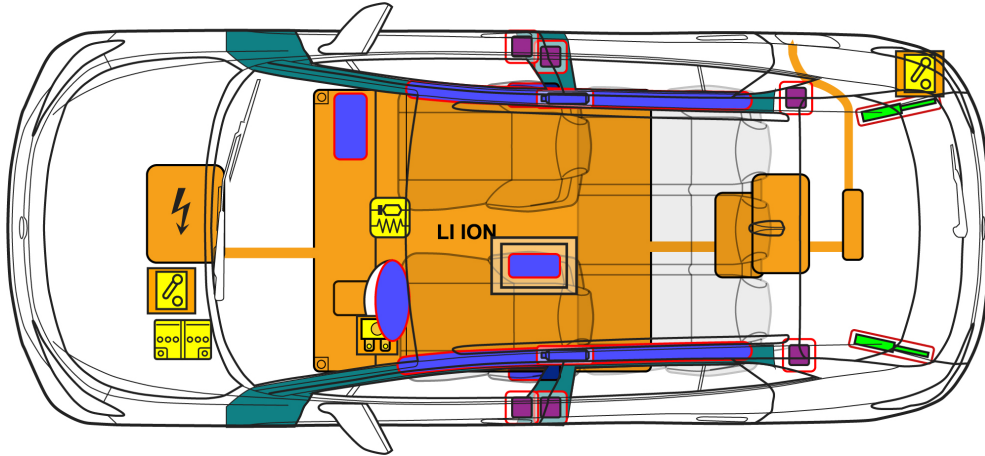

**Note:** The illustration shows the maximum possible range of equipment.

	Airbag		Stored gas inflator		Seat belt pretensioner		SRS control unit		Pedestrian protection active system
	Automatic rollover protection system		Gas strut / preloaded spring		High-strength zones		Special attention		
	Battery pack, low-voltage		Ultracapacitor, low-voltage		Fuel tank		Gas tank		Safety valve
	Battery pack, high-voltage		High-voltage power cable		High-voltage disconnect		Fuse box, disabling high-voltage system		Ultracapacitor, high-voltage
	Low voltage device that disconnects high voltage		Fuse box disabling high voltage		High voltage component				

### Additional information

High-voltage disconnection point option 3 changed

### Document number

rds\_vwv\_316\_001\_en

### Version

08/2020

### Page

1 of 4



# Volkswagen ID.4

5-door model, as of 2020

## 1. Identification / recognition



The electric motor is silent. The indicator on the left of the instrument cluster (power meter) indicates whether the electric drive is switched "OFF" or "READY" for operation.

Lettering



Charging connection



Engine compartment

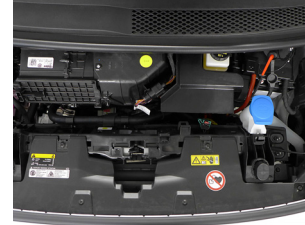

## 2. Immobilisation / stabilisation / lifting

### Immobilize the vehicle

Apply the parking brake.



### Lifting points

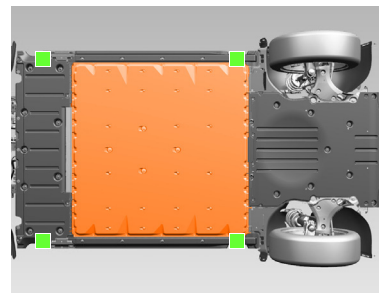

 suitable lifting points

 High-voltage battery

## 3. Disable direct hazards / safety regulations

### Turn off the ignition (Powermeter "OFF")

Press the START-STOP button without depressing the brake pedal.

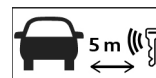

Instead of a radio key, it is also possible to use a key card or smartphone app.

### Deactivate the high-voltage system



#### Option 1: From the engine compartment



#### Disconnect the 12-volt battery

Disconnect the negative pole from the body contact point.

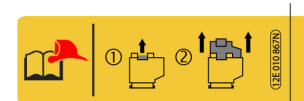



# Volkswagen ID.4

## 5-door model, as of 2020



### Option 2: from the passenger compartment

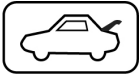
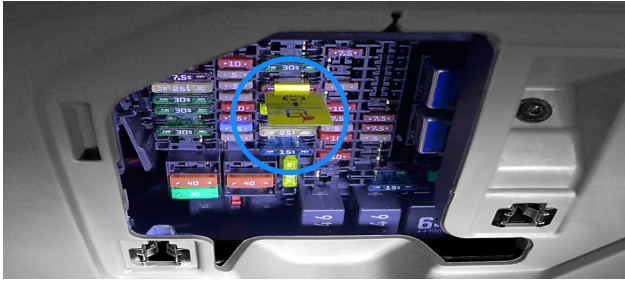

### Option 3: From the luggage compartment

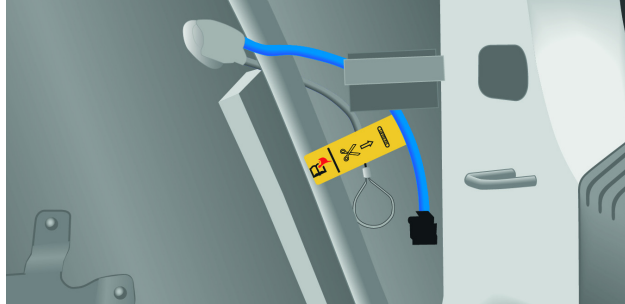

Do not touch, cut or open high-voltage components and high-voltage batteries!  
Wear appropriate protective equipment!

In the event of an accident in which the airbags are deployed, the high-voltage system will be automatically deactivated. The high-voltage system is de-energised approx. 20 seconds after deactivation.

### Disconnect from the charging station (emergency release)

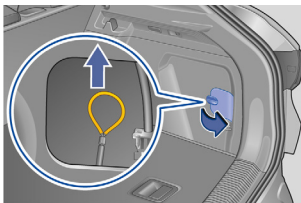

1. Remove the right side panel.
2. Locate the loop of the emergency release (without the yellow flag).
3. Pull the loop.

## 4. Access to the occupants

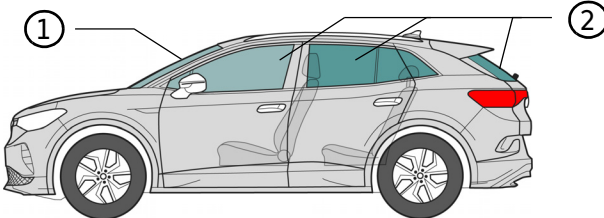

### Glas types:

- ① Laminated safety glass
- ② Toughened safety glass

## 5. Stored energy / liquids / gases / solids



400 V



12 V

### Additional information

High-voltage disconnection point option 3 changed

### Document number

rds\_vvw\_316\_001\_en

### Version

08/2020

### Page

3 of 4



# Volkswagen ID.4

## 5-door model, as of 2020



If coolant escapes from the battery cooling system, there is a risk of a thermal reaction in the high-voltage battery.  
Monitor the temperature of the high-voltage battery!



### 6. In case of fire



Lithium-ion batteries can become damaged or improper  
Use promptly or with a delay to ignite or after the Ignite fire fighting again!  
Wear appropriate protective equipment!

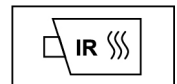

### 7. In case of submersion

After rescuing the vehicle from the water, deactivate the high-voltage system (see Chapter 3) and allow the water to drain. Wear appropriate protective equipment!

### 8. Towing / transportation / storage



Do not tow a vehicle that has been involved in an accident on its drive axles.  
Deactivate the high-voltage system (see Chapter 3).  
Park the vehicle at a safe distance, at least 5 m, from buildings and other vehicles (quarantine area).



Lithium-ion batteries can self-ignite, or re-ignite after a fire has been extinguished.

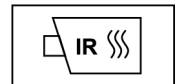

### 9. Important additional information

### 10. Explanation of pictograms used

flammable	explosive	corrosive	Hazards to the human health	Environmental hazard	Electric vehicle	High voltage warning	Caution, danger
	<b>LI ION</b>						
Use lots of water to extinguish the fire	Lithium-ion battery	Dangerous voltage	Use thermal Infrared camera	Remove smart key			